



**thermoscreens®**

## AIR CURTAIN C SURFACE MOUNTED RANGE



## INSTALLATION, OPERATION AND MAINTENANCE INSTRUCTIONS

**English**

# 1 CONTENTS

	Page
1 CONTENTS .....	2
2 ELECTRICAL SAFETY .....	3
3 SPECIFICATIONS .....	3
4. INTRODUCTION .....	4
5. DELIVERY CONTENTS .....	5
6. TOOLS REQUIRED.....	5
7. INSTALLATION .....	6
8. ACCESS FOR ELECTRICAL CONNECTION.....	8
9. REMOTE CONTROL INSTALLATION .....	9
10. REMOTE CONTROL SETTINGS.....	9
11. EXTERNAL CONTROLS.....	10
12. MULTIPLE AIR CURTAIN SYSTEMS.....	11
13. SYSTEM CONFIGURATION.....	12
14. FAN SPEED SELECTION .....	13
15. REMOTE CONTROL OPERATION.....	13
16. COMMISSIONING THE SYSTEM.....	15
17. SIGN OFF .....	15
18. FAULT CONDITIONS.....	16
19. SERVICE & MAINTENANCE .....	17
20. WARRANTY .....	18
APPENDIX 1 — Dimensions of C Surface Mounted Air Curtain .....	19
APPENDIX 2A — WIRING DIAGRAM C1000E, C1500E and C2000E .....	20
APPENDIX 2B — WIRING DIAGRAM C1000W, C1500W and C2000W .....	21
APPENDIX 2C — WIRING DIAGRAM C1000A, C1500A and C2000A.....	22
21. DECLARATION OF CONFORMITY .....	23

## 2 ELECTRICAL SAFETY

### Electrical Supply and Wiring to the Air Curtain

All electrical wiring and connections MUST be carried out by a competent qualified electrician in accordance with the latest edition of IEE wiring regulations and local statutory regulations if applicable.

- A 1 phase or 3 phase local isolator having a contact separation of at least 3mm on all poles must be fitted in the electrical supply to the air curtain and located in an accessible position adjacent to the unit.
- The appliance must be connected by cables having an appropriate heat resistant temperature rating.
- All supply cables, circuit breakers and other electrical installation equipment must be correctly sized for the air curtain model being installed; see section 3: Specifications.
- Models operating on a 3 phase electrical supply - see section 3: Specifications - require a neutral connection (3N~).
- A 25mm size cable gland or conduit connector of IP21 rating or above should be used for the Electrical Supply into the air curtain.
- See Wiring Diagrams for connecting electrical supply and control cables to the air curtain. The air curtain must be earthed.

## 3 SPECIFICATIONS

Table 1

Air Curtain Model No	Electrical Supply (V/ph/Hz)	Rated Electrical Power Input (kW)	Rated Current per phase (A)	Heat Output [Low/High] (kW)	Weight (kg)
C1000A	230/1/50	0.15	0.7	–	16
C1500A	230/1/50	0.20	0.9	–	21
C2000A	230/1/50	0.25	1.1	–	31
C1000W	230/1/50	0.15	0.7	3.0 / 6.0	18
C1500W	230/1/50	0.20	0.9	4.5 / 9.0	26
C2000W	230/1/50	0.25	1.1	6.0 / 12.0	37
C1000E	400/3/50	9.15	13.7	4.5 / 9.0	16
C1500E	400/3/50	12.20	18.3	6.0 / 12.0	23
C2000E	400/3/50	18.25	27.2	9.0 / 18.0	33

## 4. INTRODUCTION

Established in the 1960s, Thermoscreens is a leading air curtain manufacturer that exports to over 60 countries worldwide.

As with all our products, the C range of air curtains is designed with energy efficiency in mind.

C models suffixed E, W or A are designed to be surface mounted inside a building and located horizontally over a doorway.

They must not be installed on the outside of a building or built into a cabinet or recessed in any way.

Please complete the following details for your reference:

Date of Purchase .....  
Place of Purchase .....  
Serial Number .....

Proof of purchase is required to make a claim under warranty.



**thermoscreens®**

Thermoscreens Ltd  
St. Mary's Road  
Nuneaton  
Warwickshire  
England  
CV11 5AU

Email: [sales@thermoscreens.com](mailto:sales@thermoscreens.com) — <http://www.thermoscreens.com>

Tel: +44 (0) 24 7638 4646 — Fax: +44 (0) 24 7638 8578

## 5. DELIVERY CONTENTS

The following items are supplied in the box at delivery.

**NOTE:** If any parts are missing or damaged contact your place of purchase.

### C Surface Mounted Air Curtain



**Note:** End caps are supplied loose to be fitted during installation

### Ecopower Remote Control (for Electric and Water Heated units)



Supplied with 6m RJ Control Cable

### Remote Control Switch (for Ambient units)



### Wall Brackets and M6 Fixing Bolts



3 brackets for C1500  
& C2000 units

### 3-port control valve (for water heated units)



Fitted in pipework to  
air curtain by installer

### Outdoor Air Thermostat (Optional – supplied by Installer)



Used for simple weather  
compensation control  
(disables heating on a warmer day)

## 6. TOOLS REQUIRED

The following tools are required for installation:

- Flat blade screwdrivers
- Pozi head screwdrivers
- 10mm spanner
- Adjustable spanner
- Electric drill
- Ladders
- Appropriate lifting equipment

## 7. INSTALLATION

The air curtain is designed to be located horizontally over a doorway. It must not be installed outside of the building.

### 7.1 Location

Mount the air curtain above and as close to the doorway as possible, with:

- the discharge grille not more than 3m above floor level
- at least 100mm clearance (air gap) above electric/water heated air curtains, see Fig 1

Beware of doorway top edges, structural beams, door opening/closure devices, etc., which may interfere with the air stream and affect the location of the unit.

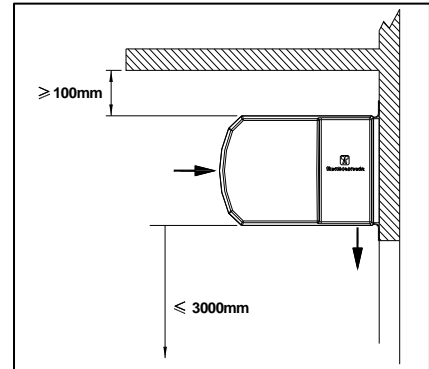

Fig 1

**NOTE:** For the air curtain to work well the width of the open doorway should be less than the length 'A' of the air curtain, see Appendix 1.

### 7.2 Wall Fixing

**NOTE:** Use suitable wall fixing bolts (not supplied) to fix the unit to the wall, taking into account the type of wall and the weight of the unit (see section 3: Specifications).

- Step 1** Bolt all wall brackets to the rear face of the unit as shown in Fig 2, using the M6 fixing bolts supplied.
- Step 2** Drill fixing points in the wall, referring to Appendix 1 for correct positioning.
- Step 3** Screw in the top wall bolts leaving a small gap between the screw head and the wall.
- Step 4** Lower the unit onto the bolts via the key-hole slots in the top of the wall brackets and screw in the bottom wall bolts.
- Step 5** Tighten all fixing bolts until the air curtain is safely secured to the wall.



Fig 2

## 7.3 Ceiling Suspension

M6 threaded rods (not supplied) are used to suspend the unit from the ceiling.

Suspend the unit from the ceiling as follows:

**Step 1** Screw the threaded rods into all of the holes in the top face of the unit as shown in Fig 3.

**NOTE:** Do not screw hanging rods too far in as they could interfere with internal components.

**Step 2** Fit M6 locking nuts (not provided) to prevent the rod rotating and coming away from the casing.

**Step 3** Secure each suspension rod to a suitable structure that can support the weight of the unit (see section 3: Specifications for weights).

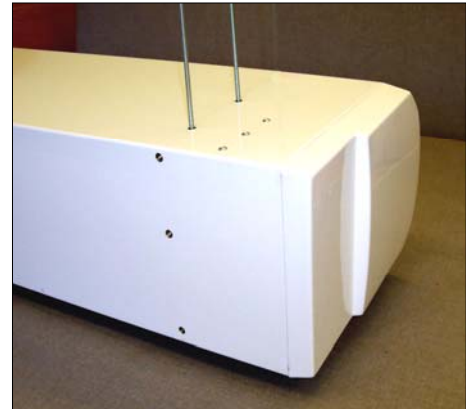

Fig 3

**WARNING:** It is the sole responsibility of the installer to ensure that the fixing locations and suspension system used are suitable for the air curtain being installed.

## 7.4 LPHW Models

For LPHW models ensure that water isolation valves are fitted in the flow and return pipework adjacent to the air curtain and connected correctly as shown in the diagram in Appendix 1.

For the design of the water pipework system and pump, water flow rates and pressure drops for maximum heat output of the air curtain are given in Table 2 below.

Table 2

Air Curtain	Water Flow Rate (l/min at 82/71°C)	Water Pressure Drop (kPa)
C1000W, 1-row (6kW)	7.8	5.1
C1500W, 1-row (9kW)	11.7	10.9
C2000W, 1-row (12kW)	15.6	19.7

**NOTE:** Water Pressure Drop is across the flow and return pipework to the air curtain and includes for the coil fitted inside the unit and the valve fitted in the heating pipework to the unit. Water flow rates and pressure drops at different water temperatures can be calculated using the Thermoscreens coil calculation programme. Visit the Thermoscreens website for details.

The installer must connect the 3-port valve in the heating pipework as shown in Figure 4 below:

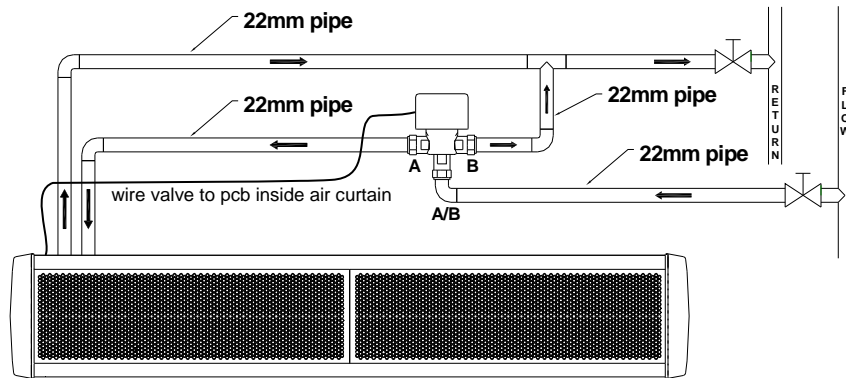

Fig 4

## 8. ACCESS FOR ELECTRICAL CONNECTION

### 8.1 How to access terminals

To gain access to the air curtain for connection and commissioning, remove air inlet grilles and bottom access panel as explained below.

First remove the plastic end caps at each end of the unit, if fitted, by pulling off to the side.

**NOTE:** All air curtain panels are protected in a plastic film. When access panels are removed this film can be removed.

#### 8.1.1 Remove air inlet grilles

Using a Pozi No 1 screwdriver, remove each grille with its filter.

To remove, insert screwdriver into the elongated hole at the bottom corner of the grille (see Fig 5) and turn the screw one quarter of a turn anticlockwise.

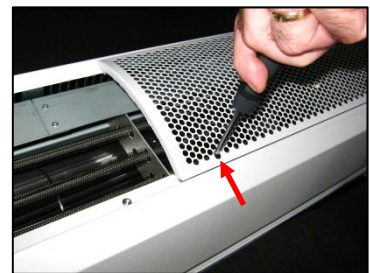

Fig. 5

#### 8.1.2 Remove bottom access panel

Unfasten the securing screw at each end (see 1, Fig 6) and, if applicable, two screws in the centre (C1500 and C2000 units only).

To remove, slide the access panel (see 2, Fig 6) out forwards.

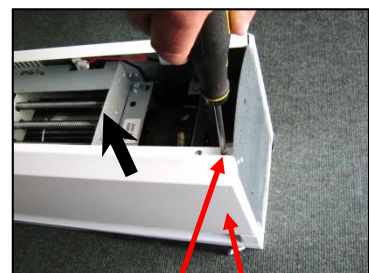

Fig. 6

1 2



## 9. REMOTE CONTROL INSTALLATION

Mount the Ecopower remote control in a convenient position directly to the wall or onto a switch box.

### 9.1 Wall mounting

- Step 1** Using a screwdriver undo the screw on the top of the remote control case and pull the back case away (see Fig 7).
- Step 2** Feed one end of the RJ control cable through the back case, secure it, then screw the back case to the wall using suitable fixings (not supplied).
- Step 3** Connect the RJ plug to the RJ socket on the PCB in the remote control.
- Step 4** Refit the front case.

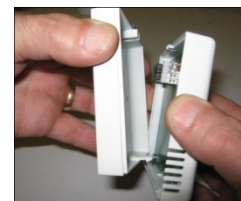

Fig 7

### 9.2 Switch box mounting

- Step 1** Using a screwdriver undo the screw on the top of the remote control case and pull the back case away (see Fig 7).
- Step 2** Feed one end of the RJ control cable through the switch box, feed and secure the RJ control cable through the back case and secure back case to switch box using 2 mounting screws (not supplied) (see Fig 8).
- Step 3** Connect the RJ plug to the RJ socket on the PCB in the remote control.
- Step 4** Refit the front case.



Fig 8

**NOTE:** For optional remote control settings see Section 10.

## 10. REMOTE CONTROL SETTINGS

On the back of the PCB inside the Ecopower Remote Control you will find four DIP switches that provide the following optional features, see Table 3:

Table 3

DIP	Feature	Explanation	Default	Notes
1	Reset on power-up	On restoring power after an electrical interruption all Remote Control settings are retained	ON	<b>WARNING!</b> – Fans start on their own after power is restored
2	Stop fan on cold	Fans are switched off when heating level is achieved (AUTO mode only)	OFF	
3	Never blow cold	Air curtain always heats in AUTO mode	OFF	Will not go to ambient mode
4	Room air temperature control	Enables the room air sensor in the Remote Control	OFF	Disables all other temperature sensors

# 11. EXTERNAL CONTROLS

## 11.1 Remote switch contacts IN0, IN1

Terminals IN0 and IN1 on the Ecopower PCB inside the air curtain can be used to provide different control strategies using remote volt-free contacts (see Fig 9). This could be to provide remote On/Off from a timer or BMS Digital/Output contact, to work with a door switch or for simple weather compensation control to disable heating when outdoor air temperatures become warmer. Table 4 describes the different functions:

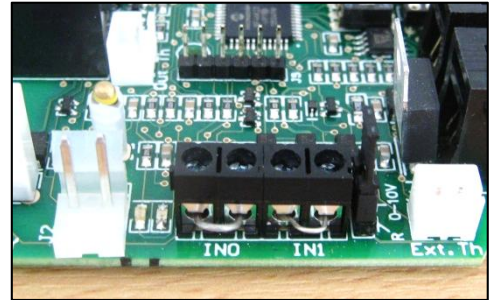









Fig 9

Table 4

Function	IN0		Notes
			
Remote On/Off (INHIBIT)	Unit operates normally in MANUAL Mode or AUTO Mode from the Remote Control	Unit switches off after 15s, with fan run-on at Medium fan speed if DIP 2 = OFF	Use the Remote Control to set up unit and then hide it away if required. *  On/Off is then done via IN0 using a remote volt-free contact.

Function	IN1		DIP 4	IN0	Notes
					
Door Switch Control	After 30s the heating is disabled and the fan goes to low speed	Unit operates normally in MANUAL Mode or AUTO Mode from the Remote Control	ON		Door Open:-  Normal Control  Door Closed:-  Heating Off Low Fan Speed
Summer Winter	Unit operates normally in MANUAL Mode or AUTO Mode from the Remote Control <i>COLD DAY</i>	Heating is disabled straight away, Fan speeds operate normally from the Remote Control <i>WARM DAY</i>	OFF		Simple weather compensation control using an outdoor air thermostat with volt free contacts (see Section 11.3)

**NOTE:** Wire volt-free, remote switch contacts to 2-way screw terminals IN0 and IN1 using 2-core cable.

**WARNING:** Do not apply any voltage to terminals IN0 and IN1 as this will damage the Ecopower PCB inside the air curtain.

\* **NOTE:** The Ecopower Remote Control must stay plugged-in for the air curtain to keep working. An optional plug-in EEPROM is available from Thermoscreens so the Remote Control can be unplugged and the air curtain stay working. Visit the Thermoscreens website for details.

## 11.2 Overheat safety cut-out indication

For electric heated air curtains the Ecopower PCB includes a fault indication signal for if the overheat safety cut-out on the electric heater operates.

Volt free changeover contacts (6A 250VAC 30VDC) can be wired via the 3-way screw terminal "HEALTHY" (see Fig 10).

Refer to Section 18.1: Overheat Safety cut out, for how to reset a overheat safety cut-out situation.

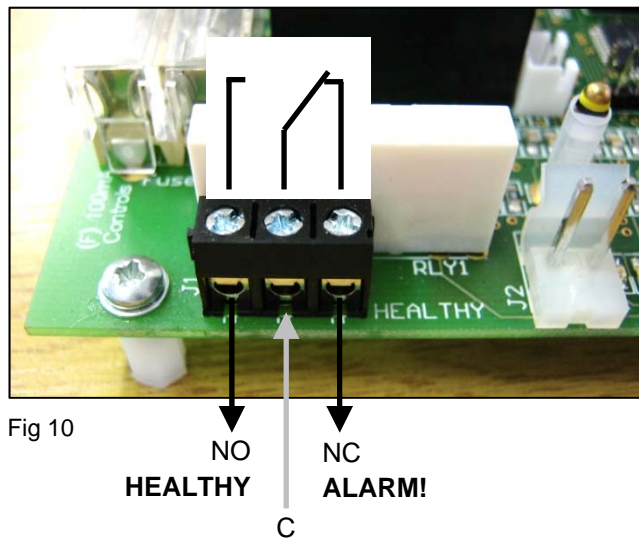

Fig 10

## 11.3 Weather compensation control (Summer/Winter)

To save heating energy on warmer days a simple weather compensation (Summer/Winter) heat control strategy can be used. Fit an outdoor air thermostat with volt-free contacts (supplied by the installer) to a north facing wall.

Use a 2-core cable to connect the outdoor air thermostat to 2-way terminal IN1 on the Ecopower PCB (see Fig 11)

On the Ecopower PCB, set DIP 4 to OFF as per Table 4, (see Section 11.1: Remote switch contacts IN0, IN1).

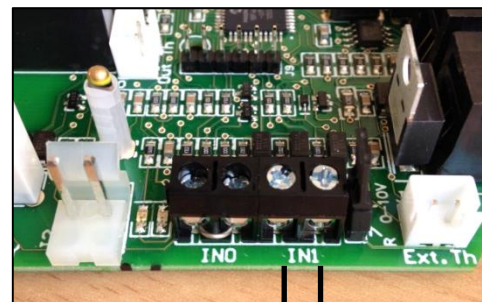

Fig 11

Switch Contact Closed = Heating Enabled (cold day)  
Switch Contact Open = Heating Disabled (warm day)



**WARNING:** Do not apply any voltage to terminal IN1 as this will damage the Ecopower PCB.

**NOTE:** To promote increased energy saving a more advanced weather compensation control strategy is available from Thermoscreens. Using a heating curve, the discharge air temperature of the airstream coming from the air curtain is controlled against the outside air temperature. Visit the Thermoscreens website for details.

## 12. MULTIPLE AIR CURTAIN SYSTEMS

For master/slave control, plug and connect units together with Thermoscreen RJ extension cables (not supplied) as per Figure 12 below. Each air curtain must have its own electrical supply.

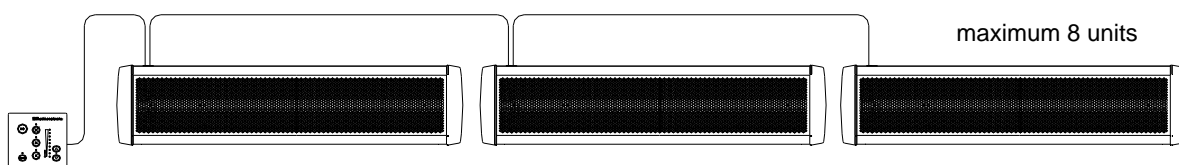

Fig 12

# 13. SYSTEM CONFIGURATION

## 13.1 Optional features

**WARNING:** Isolate and disconnect air curtain from the power source before making any changes.

DIP switches on the air curtain Ecopower PCB (see Fig 13) provide the following optional features, as explained below:

- Fan heat interlock
- Disable fan run-on
- Thermostat master (for master/slave installations)
- Weather compensation heat control (Summer/Winter)
- Door switch control



Fig 13

Feature	DIP setting	Default	Notes
<p><b>Fan heat interlock</b> Allows fan speed to govern heat output on electric heated units.</p> <p>If low or medium fan speed is selected, a lower heat output results. High heat operates only on high fan speed.</p>	<p><b>DIP 1</b></p>	<p><b>ON</b></p> <p>Heat output is governed by fan speed.</p>	<p>This feature is only used with electric heated air curtains to limit very high air temperatures.</p> <p>Set DIP1 to OFF if unit is water heated or ambient.</p>
<p><b>Disable fan run-on</b> The 2 minute fan run-on after switch off is enabled or disabled on electric heated air curtains.</p>	<p><b>DIP 2</b></p>	<p><b>OFF</b></p> <p>Fan run-on at medium speed enabled.</p>	<p>Must only be used for water heated or ambient air curtains. Each air curtain must have DIP2 set to ON for no fan run-on.</p>
<p><b>Thermostat master</b> For master/slave installations. Only the air sensor in the thermostat master air curtain is used to measure air temperature.</p> <p>Set DIP 3 to ON in the air curtain that will be the master unit.</p>	<p><b>DIP 3</b></p>	<p><b>OFF</b></p> <p>Air curtains in master/slave systems all act independently.</p>	<p>Air sensor thermistors in all slave air curtains will be ignored.</p> <p>Stops some units blowing cold air and others blowing warm air in master/slave systems on larger doorways.</p>
<p><b>Weather compensation control or Door switch control</b></p> <p>Simple weather compensation control to save heating energy.</p> <p><u>or</u> Door switch control.</p>	<p><b>DIP 4</b></p>	<p><b>OFF</b></p> <p>IN1 Weather compensation</p> <p><b>ON</b></p> <p>IN1 Door switch</p>	<p>See section 11.1 Remote Switch Contacts IN0 and IN1 for details</p> <p>Weather compensation control is the same as Summer/Winter control</p>

**NOTE:** ■ — Black rectangle is moveable head of DIP switch.

**NOTE:** A range of advanced factory fitted and plug-in control options are available from Thermoscreens to enhance the performance of the Ecopower PCB controller inside the air curtain. These include advanced weather compensation control using a heating curve, outlet air temperature control, ECObus® Modbus BMS control, modulating heater outputs and EEPROMs for non-standard control strategies. Visit the Thermoscreens website for details.

## 14. FAN SPEED SELECTION

Factory settings for the 3 fan speeds are shown in Table 5 below:

(refer also to wiring diagrams in Appendix 2)

Table 5

Fan Speed	Maximum air velocity at outlet grille (m/s)	Maximum air curtain mounting height (m)	Sound Pressure Level of air curtain [dB(A) at 3m]	Air Volume Flow Rate (m <sup>3</sup> /h) [for E & A]
<b>HIGH</b> (black wire)	8.5	3.0	C1000 - 55 C1500 - 55 C2000 - 56	1250 1800 2500
<b>MEDIUM</b> (blue wire)	6.5	–	C1000 - 53 C1500 - 53 C2000 - 54	1140 1640 2275
<b>LOW</b> (red wire)	5.0	–	C1000 - 50 C1500 - 49 C2000 - 50	1025 1475 2050

Sound pressure levels dB(A) at 3m distance are for a single air curtain mounted at its maximum mounting height, operating in a room with average acoustic characteristics as defined in CIBSE Guide B5 (reverberation time 0.7s at 1kHz) and a room size equivalent to 8 air changes per hour (ac/h). Care needs to be taken when selecting air curtains for an installation as noise levels can be several dB higher if the mounting height is reduced, if the room is more 'live' (i.e. hard surfaces, no furnishings or absorbent materials), if the room is smaller than 8 ac/h equivalent or a combination of these factors. Noise levels will also increase if more than one air curtain is installed at the same doorway (e.g. +3dB(A) for 2 equal point sources: direct field).

## 15. REMOTE CONTROL OPERATION

### 15.1 Remote Control Switch (for Ambient units)

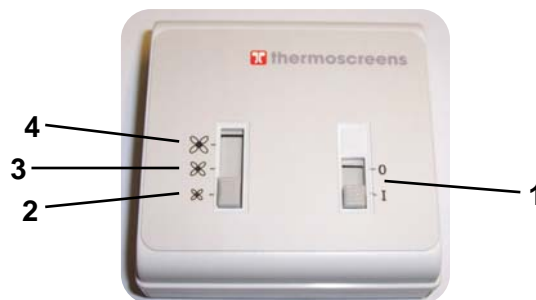

#### 1 On/Off

Turns the air curtain fans On or Off.

#### 2, 3 & 4 Fan speed

Switch fan speed between Low, Medium and High respectively.

## 15.2 Ecopower Remote Control (for Electric and Water Heated units)

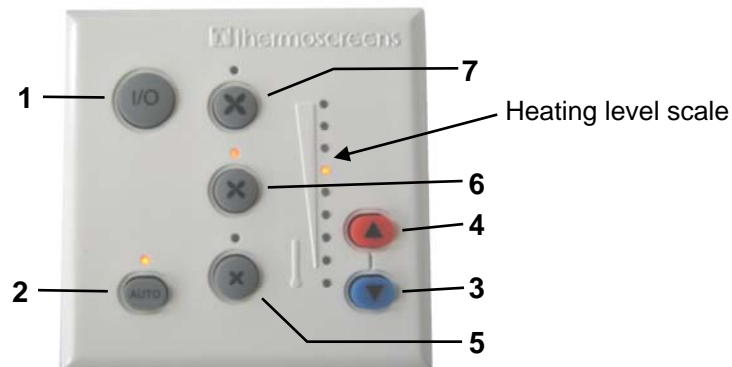

Use the Remote Control to operate the air curtain as follows:

### 1 On/Off

Turns the air curtain On or Off.

**NOTE:** If an electric heated air curtain is heating when switched off the fan will run-on for approximately 2 minutes to dissipate excess heat.

### 2 Manual/Automatic

Switches between Manual and Automatic modes.

The Auto On indicator LED is lit for "Auto Mode" and unlit for "Manual Mode".

### 3 & 4 Heating level controls

#### Manual mode

Select heating level from zero, to half heat, to full heat by stepping up or down with the heating level controls. The heating level scale shows the level selected.

#### Automatic mode

Heat output is controlled automatically according to:

- Inlet air temperature, or
- Room air temperature

This is dependent on the settings made in Section 10: Remote Control Settings (DIP switch 4).

### 5, 6 & 7 Fan speed

Switch fan speed between Low, Medium and High respectively. The appropriate LED illuminates.

## 16. COMMISSIONING THE SYSTEM

### 16.1 Verify system operation

To commission the system, verify the following conditions are met:

- All fans are working.
- Fans operate at Low, Medium and High speeds.
- There is no excessive mechanical noise coming from the fans.
- When heating is selected, the air stream from the discharge grille warms up across the whole length of the air curtain.
- When set to manual with fans set to high speed, heating increases as higher heat is selected.
- Warm air reaches across the doorway with door open or closed.
- Ecopower Remote Control operates correctly in both manual and auto modes.

### 16.2 Instruct customer and hand over

Before leaving site, hand over the installation to the customer/end user or their representative.

**Explain** that any person operating the air curtain must be given supervision and instruction by the person responsible for their safety, concerning the safe use of the unit and to understand any hazards involved. Children and those with reduced physical, sensory or mental capabilities should not operate the air curtain.

**Recommend** that the doorway should be closed whenever possible but that during times of high pedestrian use it will become an 'open doorway'. The air curtain then serves an essential purpose by saving energy and providing comfort to occupants.

**Explain** that the inlet grilles and air filters (if fitted) must be cleaned regularly and the unit serviced at schedule intervals – see section 19: Service & Maintenance.

**NOTE:** Leave these instructions with the customer/end user or their representative!!

## 17. SIGN OFF

Complete the following once commissioning is completed:

Installer signature		Customer signature	
Installer name		Customer name	
Installer company		Customer company	
Date		Date	

## 18. FAULT CONDITIONS

### 18.1 Overheat Safety cut-out

An overheat fault in electric heated units may cause the overheat safety cut-out(s) to operate.

This is indicated by flashing LEDs on the Remote Control and a red status LED on the Ecopower PCB inside the air curtain.

Before resetting ensure there is adequate air flow from the air curtain and the unit has been commissioned as per section 16.

To reset a overheat safety cut-out:

- Step 1** Switch off the electrical supply to the air curtain.
- Step 2** Allow time for the air curtain to cool down, typically 10 minutes.
- Step 3** Switch on the electrical supply to the air curtain.
- Step 4** Press the Auto button on the Ecopower remote control 4 times.

Air curtain heaters will then operate and after 30 seconds the LEDs on the remote control will stop flashing and the status LED on the Ecopower PCB in the air curtain will flash green.

### 18.2 Fuses

In the event of an electrical fault internal electrical fuses may operate.

There are two internal fuses located on the Ecopower PCB inside the air curtain:

- Fuse 6.3A(T) supplies the fan motors within the air curtain
- Fuse 100mA(F) controls the circuitry of the Ecopower PCB

### 18.3 Ecopower PCB status indication

There is a status LED on the Ecopower PCB inside the air curtain (See LED shown on Wiring Diagrams in the Appendix).

This indicates the status of the Ecopower Control system as follows:

1. LED flashing green – operation normal
2. LED flashing red – low supply voltage, remote control not plugged in or RJ cable fault
3. LED permanently red – overheat safety cut-out(s) open circuit from an overheat situation (see Section 18: Fault Conditions for how to reset)



## 19. SERVICE & MAINTENANCE

**WARNING:** Failure to adequately maintain the unit and provide a suitable cleaning schedule will result in a loss of performance and reduced life expectancy of the air-curtain and possible overheating and fire risk with electric heated units.

### 19.1 Every week

**NOTE:** Weekly maintenance can be carried out by the Cleaner or Janitor from floor level.

Turn off the air curtain to prevent entry of dust then clean the face of the air inlet grilles and air filters inside the grilles using a vacuum cleaner with an extension tube and brush.

### 19.2 Every 3 months

**WARNING:** Before servicing, isolate and disconnect the air curtain from the electrical power.

**WARNING:** The following servicing and maintenance must be carried out by a competent electrician or a Thermoscreens appointed technician.

Clean and inspect the inside of the air curtain as follows:

- Step 1** Remove plastic end caps at each end of the unit by pulling off to the side.
- Step 2** Use a Pozi No.1 screwdriver to remove air inlet grilles by releasing the fasteners at the bottom corners of each air inlet grille. See Fig 5, Section 8.1.1.
- Step 3** Clean and remove any build-up of dust and dirt within the air-curtain (inlet/outlet grilles, electric heaters, fan impellers, housings and motors) using a vacuum cleaner and soft brush.

**NOTE:** Build-up of dirt on fan impellers can cause vibration, noise and excessive wear on the motor bearings.

- Step 4** Check within the unit to ensure all electrical connections and crimped terminals are tight and that all cables are in good condition.

Refit air inlet grilles after servicing. Reconnect electrical supply and test to ensure correct operation (see Section 16: Commissioning).

## 20. WARRANTY

All units are covered by a two year warranty.

Failure to adequately maintain the unit may void the warranty. If any problems are encountered, please contact your installer/supplier.

Failing this please contact the Thermoscreens warranty department.

Care has been taken in compiling these instructions to ensure they are correct. Thermoscreens Ltd. disclaims all liability for damage resulting from any inaccuracies and/or deficiencies in this documentation. Thermoscreens Ltd. retain the right to change the specifications stated in these instructions.

Thermoscreens Ltd  
St. Mary's Road Nuneaton  
Warwickshire England  
CV11 5AU

Email: [sales@thermoscreens.com](mailto:sales@thermoscreens.com)  
Tel: + 44 (0) 24 7638 4646  
Fax: + 44 (0) 24 7638 8578  
[www.thermoscreens.com](http://www.thermoscreens.com)

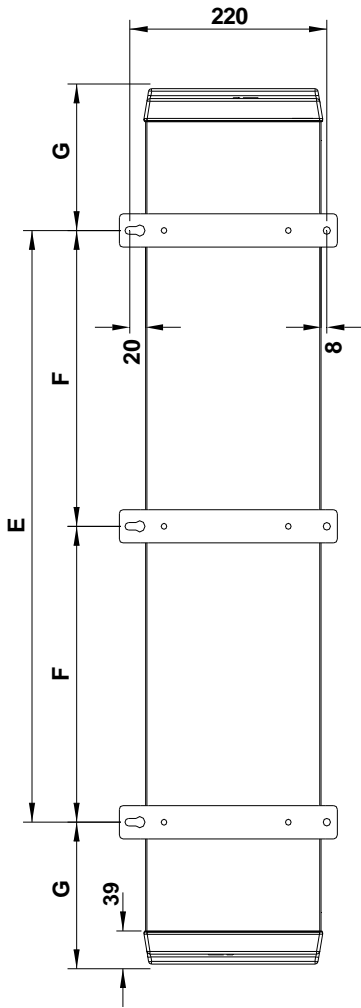
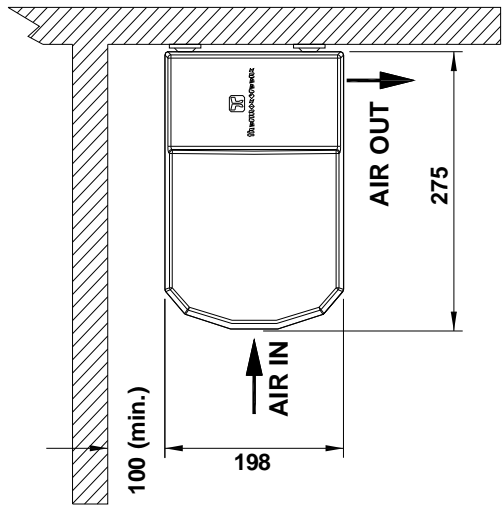

mm

Entry points for electrical supply and controls

Remote control connection interface

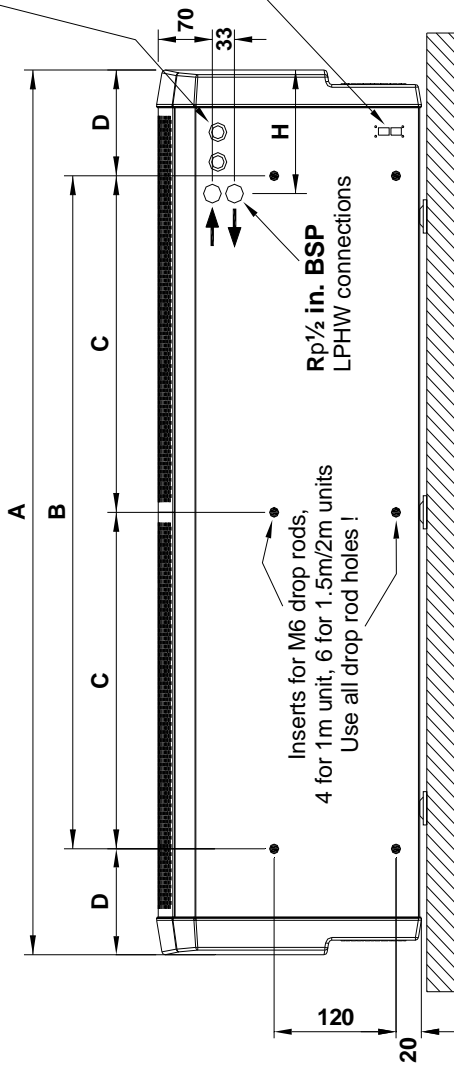

	C1000	C1500	C2000
A	1137	1669	2200
B	908	1408	1928
C	-	704	964
D	115	131	136
E	710	1208	1748
F	-	604	874
G	214	231	226
H	152	172	172

# APPENDIX 1 — Dimensions of C Surface Mounted Air Curtain

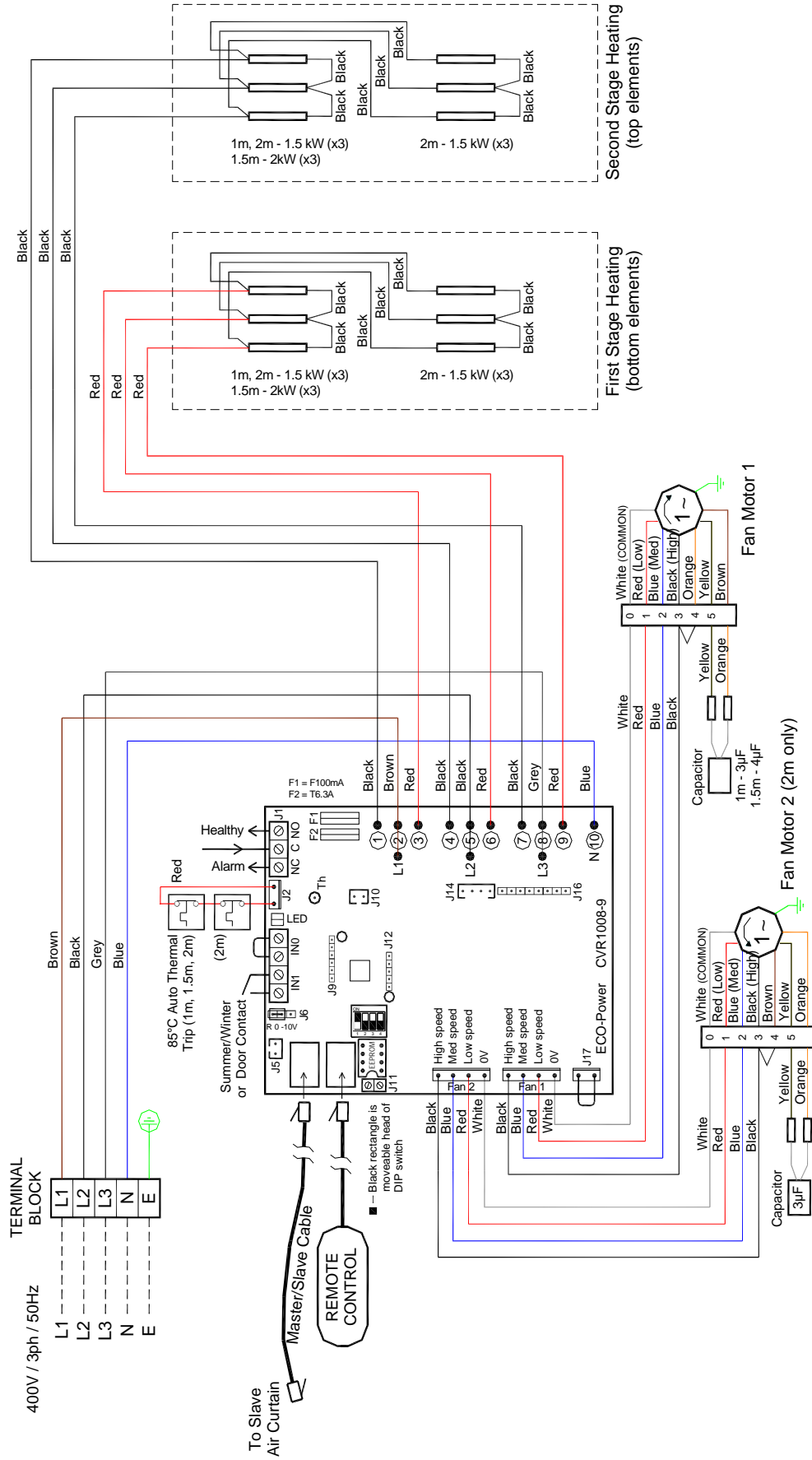

**APPENDIX 2A — WIRING DIAGRAM C1000E, C1500E and C2000E**

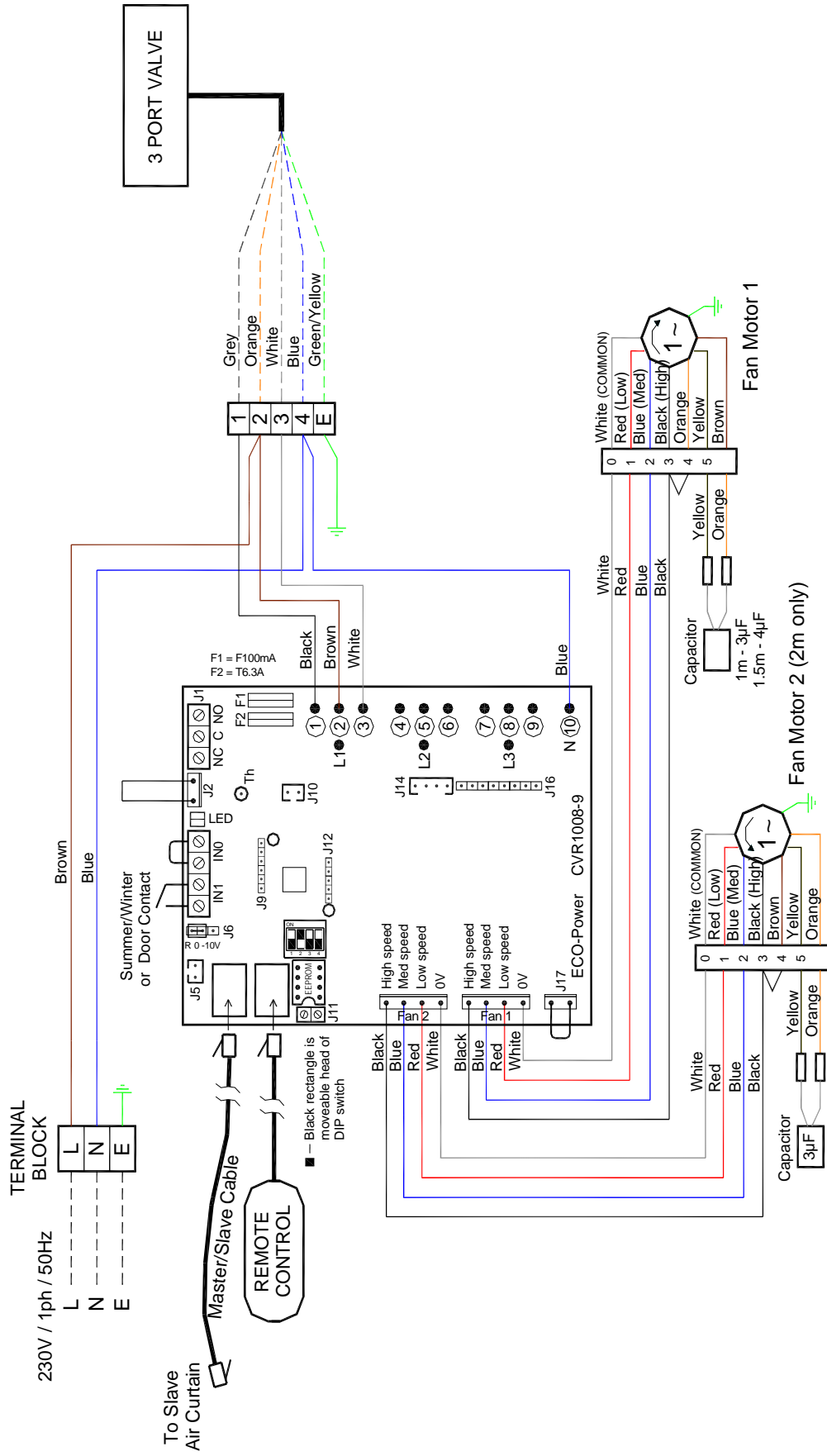

**APPENDIX 2B — WIRING DIAGRAM C1000W, C1500W and C2000W**

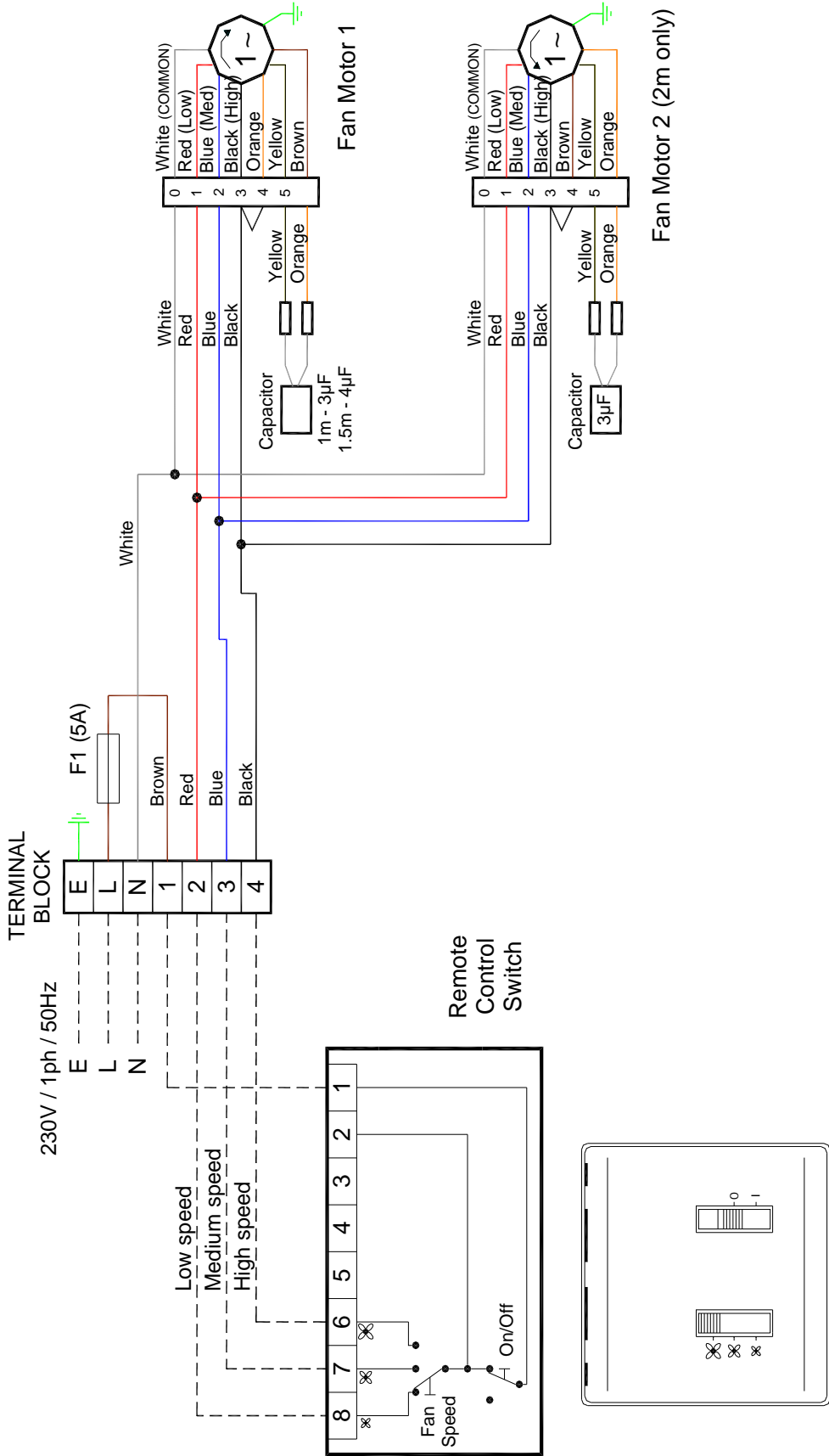

APPENDIX 2C — WIRING DIAGRAM C1000A, C1500A and C2000A

## 21. DECLARATION OF CONFORMITY

Thermoscreens Ltd.  
St. Mary's Road  
Nuneaton  
Warwickshire  
CV11 5AU  
United Kingdom  
Telephone: +44 (0)24 7638 4646  
www.thermoscreens.com



**EC DECLARATION OF CONFORMITY**  
as defined by the EC Council Directive on Machinery 2006/42/EC,  
the Low Voltage Directive 2006/95/EC, Electromagnetic Compatibility Directive 2004/108/EC,  
the Energy related Products Directive 2009/125/EC

Herewith we declare that the air movement equipment designated below, on the basis of its design and construction in the form brought onto the market by us in accordance with the relevant safety, health and performance requirements of the Machinery.  
If alterations are made to the machinery without prior consultations with us, this declaration becomes invalid.

**Designation of Equipment:** AIR CURTAINS

**Series Type:** C1000A; C1000E; C1000W; C1500A; C1500E; C1500W;  
C2000A; C2000E; C2000W  
(in Casing Styles: Surface Mount and Recessed)

**Relevant EC Council Directives:** the Machinery Directive (2006/42/EC)  
the Low Voltage Directive (2006/95/EC)  
the Electromagnetic Compatibility Directive (2004/108/EC)  
the Energy related Products Directive (2009/125/EC)

**Applied Harmonised Standards:** Machinery - EN ISO 14121-1:2007, EN 294:1992, EN 414:2000  
LVD - EN 60335-1:2012, EN 60335-2-30:2009+A11:2012  
EMC - EN 61000-6-1:2007, EN 61000-6-3:2007+A1:2011,  
EN 61000-3-2:2006+A2:2009, EN 61000-3-3:2008  
ErP - Commission Regulation (EU) No.327/2011,  
ISO 5801:2007, ISO 12759:2010

**Basis of Self Attestation:** Quality Assurance to BS EN ISO 9001: 2008  
B.S.I. Registered Firm Certificate Number FM 85224  
SGS Test Report ELS150049/2/R/DC/11;  
SGS Test Report EMC150049/1  
CE Marking Association Test Report 6799 and 6800

**Responsible Person:** Mr. P.Casey, Operations Director, Thermoscreens Ltd.

**Date:** 20 March 2014

**Signed:**