



MA & CONTACT TERMINAL Interface



Model **MAC-397IF-E**

[FOR INSTALLER]  
**INSTALLATION MANUAL**

English

# Contents

1. Safety Instructions .....	2
2. Before Installation .....	3
3. Connecting the MA & CONTACT Terminal Interface to the Indoor Unit .....	4
4. Connecting the MA & CONTACT Terminal Interface with each system .....	5
5. Dip Switch Details .....	9
6. Test Run (Check Operations) .....	12
7. Mounting the MA & CONTACT Terminal Interface Unit .....	13
8. Specifications .....	13

## 1. Safety Instructions

- Read all Safety Instructions before using this device.
- This manual contains important safety information. Be sure to comply with all instructions.
- After installing the Interface, provide this Installation Manual to the user.  
Instruct users to store their room air conditioner Instruction Manual and Warranty in a safe location.

### **Warning**

(Improper handling may have serious consequences, including injury or death.)

■ **Users should not install the Interface on their own.**

Improper installation may result in fire, electric shock, or damage/water leaks if the Interface unit falls. Consult the dealer from whom you purchased the unit or professional installer.

■ **The Interface should be securely installed in accordance with the enclosed Installation Instructions.**

Improper installation may result in fire, electric shock, or damage/water leaks if the Interface unit falls.

■ **The unit should be mounted in a location that can support its weight.**

If installed in an area that cannot support the unit, the Interface unit could fall and cause damage.

■ **Securely attach the electrical component cover to the Interface unit.**

If the electrical component cover of the Interface unit is not securely attached, dust or water penetration could occur, resulting in a fire or electric shock.

■ **Mitsubishi components or other designated components must be used for installation.**

Improper installation may result in fire, electric shock, or damage/water leaks if the Interface unit falls.

■ **When performing electrical work, adhere to the technical standards regarding electrical equipment and the interior wiring standards, follow the instructions provided in the Instruction Manual.**

Improper installation could result in a fire or electric shock.

## 2. Before Installation

### 2.1. How to Use the MA & CONTACT Terminal Interface

#### ■ Functions

##### Centralized control (Fig. 2-1)

You can turn multiple air conditioners on and off from one location. (MAC-821SC-E (8-Room))

##### Use as wired remote controller (Fig. 2-2)

You can use the MA remote controller as a wired remote controller. (PAR-21MAA)

##### Remote control (Fig. 2-3)

You can turn on and off an air conditioner from a remote location by connecting the ON/OFF contact point.

##### Status indicator output (Fig. 2-4)

You can control the operation of the relay with either of the on/off or error/ok status output signals.

#### ■ Sample System Configuration

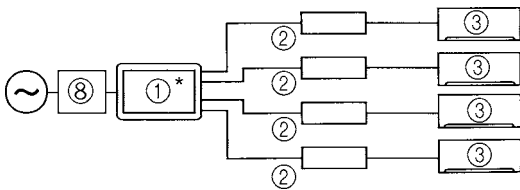

Fig. 2-1

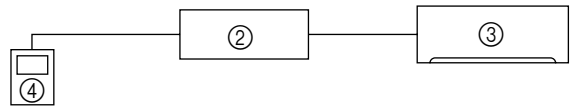

Fig. 2-2

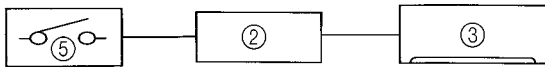

Fig. 2-3

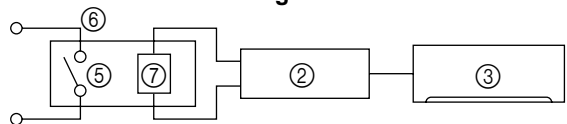

Fig. 2-4

- |  |                        |
|--|------------------------|
| ① Centralized controller (MAC-821SC-E) | ④ MA remote controller |
| ② MA & CONTACT Terminal Interface      | ⑤ Contact point        |
| ③ Indoor Unit                          | ⑥ Relay                |
|  | ⑦ Coil                 |
|  | ⑧ Breaker              |

\* A separate AC power supply is required for centralized controller.

## 2.2. Parts

Before installing the unit, make sure that you have all the necessary parts.

### ■ Accessory

①	Interface unit	1
②	Wall mounting brackets	1
③	Screws for mounting ② 3.5 × 12	4
④	Cushioning material (with adhesive)	1
⑤	Mounting cord clamp (small)	2
⑥	Mounting cord clamp (medium)	2
⑦	Mounting cord clamp (large)	2
⑧	Screws for mounting ⑥-⑦ 3.5 × 12 * Use when attaching the clamps to the interface unit	2
⑨	Screws for mounting ⑥-⑦ 4 × 10 * Use when mounting the clamps on or near the M series	1
⑩	Screws for mounting ⑥-⑦ 4 × 16 * Use when mounting the clamps and electrical wire mounting bracket	1
⑪	Fasteners (for joining the lead wires)	5
⑫	Wiring cord clamp	5
⑬	Screws for mounting ⑫ 3.5 × 12	5
⑭	Screws for mounting the interface case 3.5 × 12	2
⑮	Lead wires (6)	1

### ■ Items to Prepare at the Installation Site

A	Signal wire extension cable (if necessary) Shield wiring CVVS/CPEVS
B	Switch, relay, coin timer, etc. (if necessary) * Please use products with supplementary insulation.
C	Related products sold separately * Prepare the necessary number of parts sold separately as needed for your system.

- \* CPEVS; PE insulated PVC jacketed shielded communication cable
- \* CVVS; PVC insulated PVC jacketed shielded control cable
- PE: Polyethylene PVC: Polyvinyl chloride

## 3. Connecting the MA & CONTACT Terminal Interface to Indoor Unit

- Connect the interface unit and the indoor control board using the connecting cable that came with the interface.
- Extending or shortening the connecting cable that comes out of the interface may cause it to malfunction. Also, keep the connecting cable as far as possible away from the electrical wires and ground wire. Do not bundle them together.

### M series

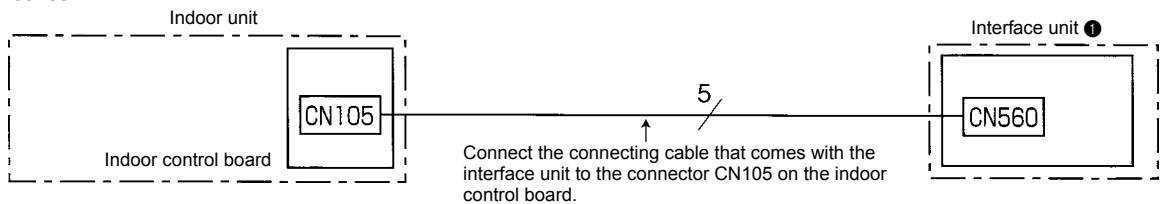

### P/S series

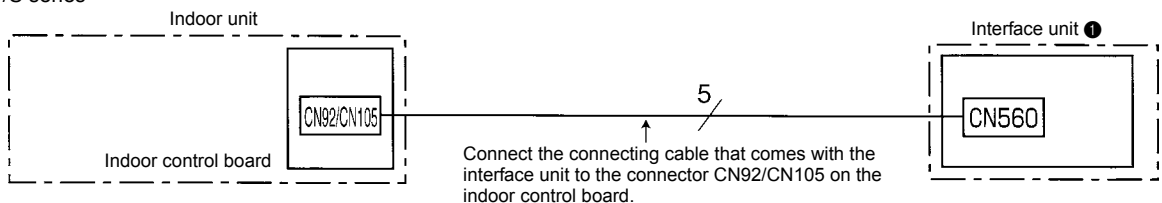

- When this interface unit is connected with Indoor Unit, timer operation cannot be set from a wireless remote controller.
- When this interface unit is connected with Indoor Unit, i-see sensor control cannot be used. Normal cooling or heating operation is performed. (MSZ-FA Series only)

## 4. Connecting the MA & CONTACT Terminal Interface with each system

(For details on each system, see the relevant instruction manual.)

- Replace the interface unit ① mounting cord clamp with a supplied mounting cord clamp ⑤-⑦ based on the thickness of the connecting cable used for each system.

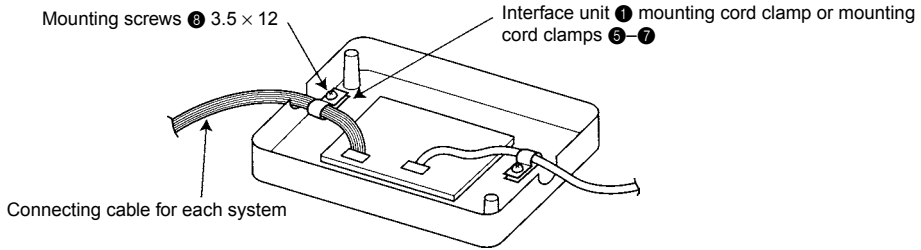

- The cables connected to the Indoor Unit should be mounted on or near the Indoor Unit. If the connecting cable is not securely mounted, the connector may detach, break, or malfunction.

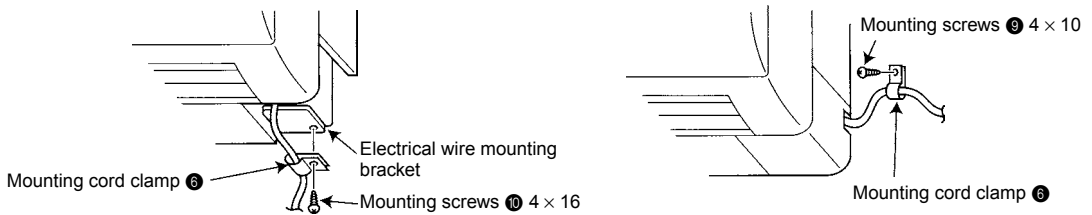

- Set the interface dip switch (SW500-502) settings before turning on the power.
- If the interface dip switch (SW500-502) settings are not set correctly, the system will not function properly.

### 4.1. Centralized Control (When Connecting to a Centralized on-off remote Controller)

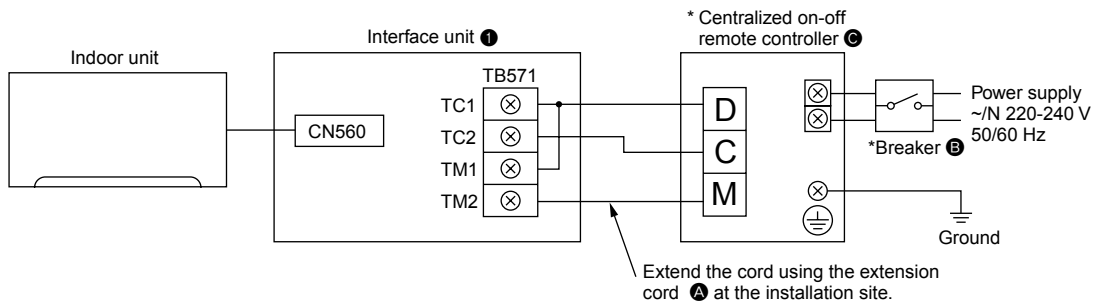

\* Refer to the installation manual of centralized on-off remote controller.

#### Dip switch settings

##### ■ SW500

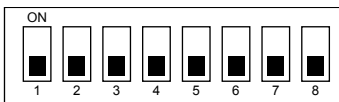

Setting required

##### ■ SW501 and SW502 do not have to be set.

##### SW501



##### SW502

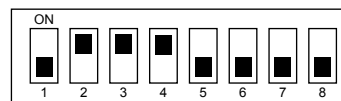

## 4.2. Use as a Wired Remote Controller (Using the MA Remote Controller)

### Note:

1. Be sure to set the “Auto Heating/Cooling Display Setting” of the MA remote controller OFF before use. When the setting is turned ON, the remote controller display may differ from the actual operating status of the unit.
  - For details on the “Auto Heating/Cooling Display Setting,” refer to the MA remote controller instruction manual.
2. A test run cannot be initiated using the test run switch on the MA remote controller.
3. The horizontal vanes on the unit cannot be operated using the louver switch.
4. The range of room temperature indication is between 10°C and 38°C.

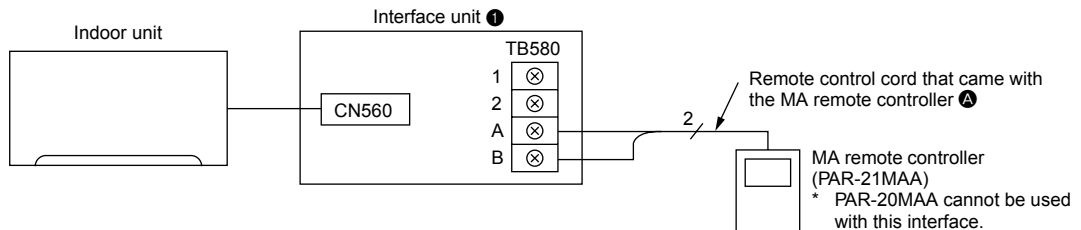

### Dip switch settings

■ SW500 does not have to be set.

### ■ SW501:

#### SW501- No. 1–4: Refrigerant address

- Set this switch when multiple indoor units (and interfaces) are connected to a MA remote controller.
- Always start the refrigerant address at “0”.
- Even when connecting multiple outdoor units, set a different refrigerant address for each indoor unit.

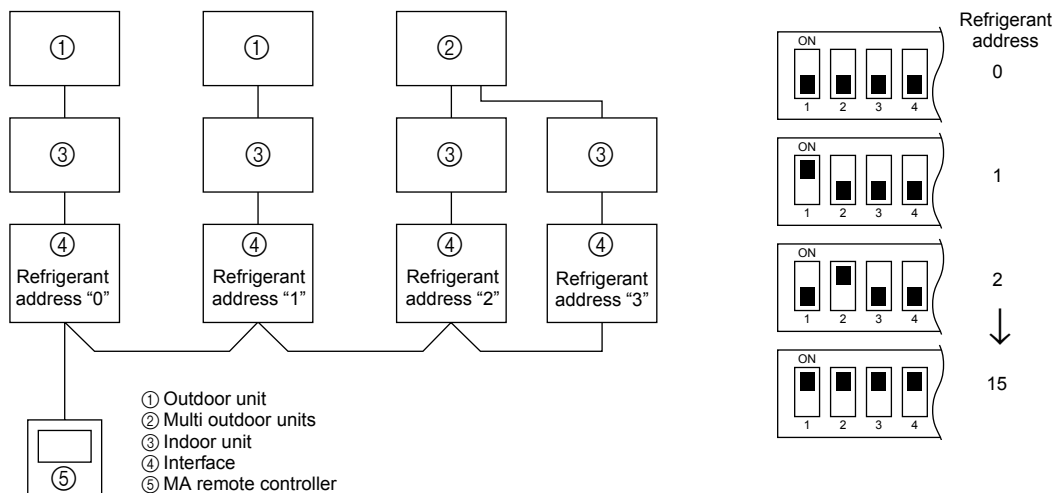

#### SW501- No. 5–6

##### M series

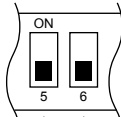

No. 5 and 6 should normally be set to OFF. Under the following conditions, however, they should be switched to ON.

Only turn this ON when the indoor units in the same group include models where the MA remote controller and indoor unit are directly connected.

Set them to ON only when using the room temperature sensor installed in the MA remote controller.

\* This can be switched when an accurate room temperature cannot be detected by the air conditioner unit. MSZ-GA and MSZ-FA Series models can not use a room temperature sensor on their MA remote controllers. (Some M series models will not allow the use of the MA remote controller room temperature sensor.)

##### P/S series

- Set SW501-No. 5 to ON
- Set SW501-No. 6 to OFF

■ **SW502:**

- Set this switch based on the functions of the Indoor Unit connected to the interface.
- See the Page 12 table and set the switch after checking the functions using the wireless remote control that came with the Indoor Unit.

### 4.3. Remote Control (Turning Indoor Unit On and Off from the Contact Point)

- You can turn Indoor Unit on and off using an on/off switch like a light switch.
- Connect the supplied lead wires (6) ⑤ to the connector CN591 on the interface board.
- Wire the remote control components, including the switches, at the installation site.
- Please use extension cords with reinforced insulation.

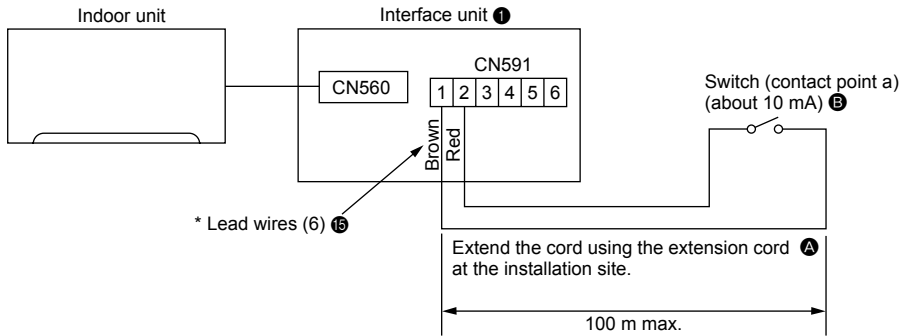

- When the switch contact point is closed (ON), the air conditioner will turn on, and when the switch contact point is open (OFF), the air conditioner will turn off.

\* When connecting the connector and the lead wire, connect them using a closed end connector as shown below.

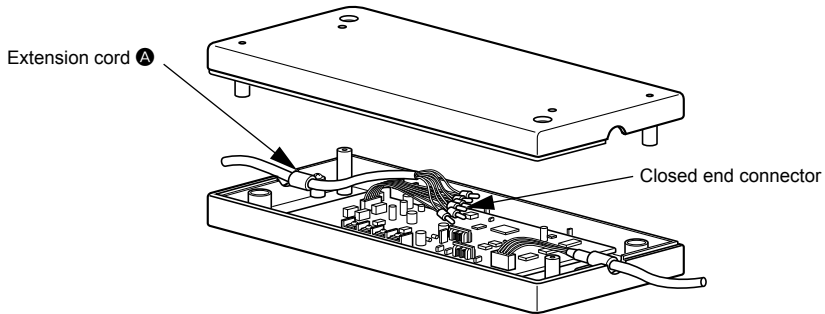

#### Dip switch settings

■ **SW500**

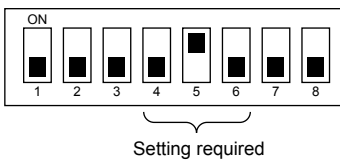

■ **SW501 and SW502 do not have to be set.**

## 4.4. Restricting Indoor Unit Operations from the Contact Point

- You can use a coin timer or light switch to ensure that Indoor unit will not operate.
- Connect the supplied lead wires (6) ⑬ to the connector CN591 on the interface board.
- Wire the remote control components, including the coin timers or switches, at the installation site.
- Please use extension cords with reinforced insulation.

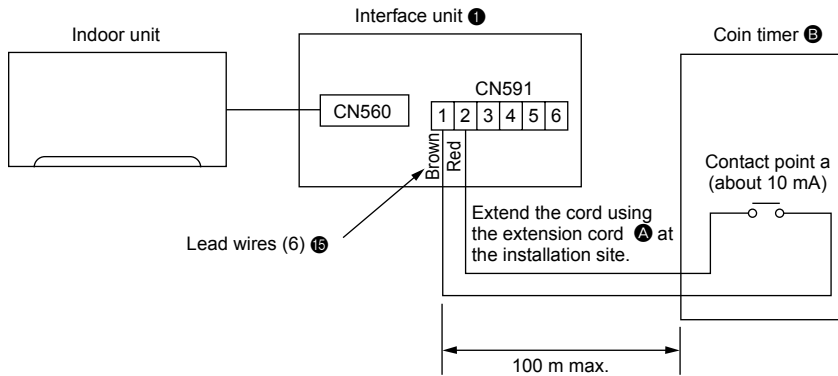

- \* When the contact point is open, the unit will turn off and will not be operable from the remote control. When the contact point is closed, the unit will turn on and will be operable from the remote control.

### Dip switch settings

#### ■ SW500

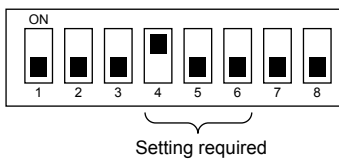

#### ■ SW501 and SW502 do not have to be set.

## 4.5. Status Signal Output Using the Relay

- You can set the external relay to ON/OFF based on whether the Indoor unit is set to either on/off or error/ok.
- Set up and wire the relay and extension cables at the installation site.
- Please use relays with reinforced insulation.

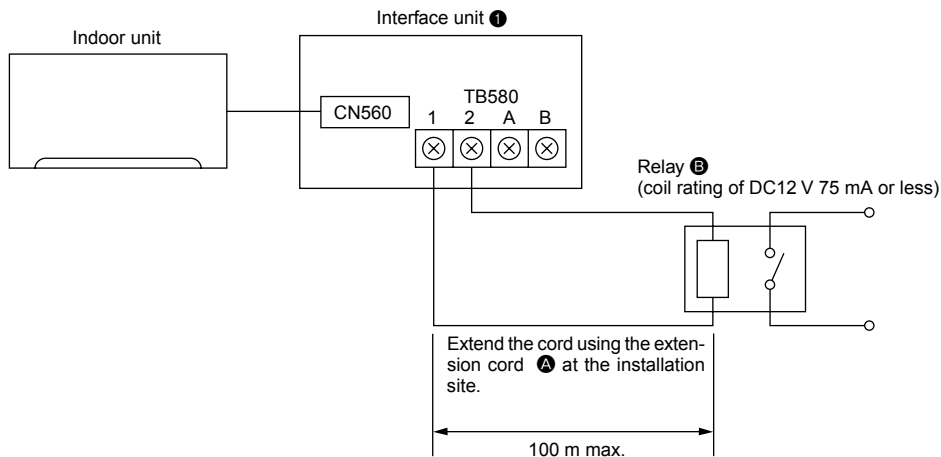



## Dip switch settings

### ■ SW500

1. When outputting the Indoor unit on/off

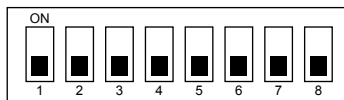

The relay is ON when the unit is running, and OFF when it is not.

2. When outputting the Indoor unit error/ok



The relay is ON when an error has occurred, and OFF when the unit is functioning properly.

■ SW501 and SW502 do not have to be set.

## 5. Dip Switch Details















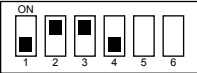

### ■ SW500 - Input/Output Mode Settings

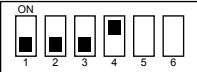
SW No.	Functions	OFF	ON	Comments
No. 1	Not in use	Set to OFF	–	Be sure to set these to OFF (When set to OFF, the unit cannot communicate with the air conditioner).
No. 2	HA terminal (CN504) input switch	Pulse input	Continuous input	There is a switch between TC1 and 2 input on the TB571.
No. 3	HA terminal (CN504) output switch	Static mode	Dynamic mode	
No. 4	Remote control (CN591) mode switch 1	See the next page	See the next page	
No. 5	Remote control (CN591) mode switch 2			
No. 6	Remote control (CN591) mode switch 3			
No. 7	Relay, extermination output mode switch	ON/OFF output	ERROR/OK output	When there is a problem while the unit is running, it will output a relay ON signal.
No. 8	Turn on/off with power option	Turn ON/OFF with power: No (unit remains OFF when the source power is turned ON)	Turn ON/OFF with power: Yes (Returns the unit to the status (ON/OFF) it was in before the power was turned OFF)	When the Auto Restart function on the air conditioner itself is set to ON, be sure to set these to OFF.

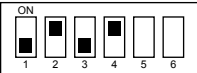
## Remote control (CN591) mode switch

SW 500			Functions	Operating Details																																				
No. 4	No. 5	No. 6																																						
OFF	OFF	OFF	Do not use the CN591 remote control	—																																				
OFF	OFF	ON	ON/OFF Prohibited/Allowed mode 1	Manual operations prohibited when CN591 No. 1 and No. 3 are closed, permitted when open. Only when No. 1 and No. 3 are closed and manual operations are prohibited. On when CN591 No. 1 and No. 2 are closed, off when open. (Cannot be operated from the remote control when manual operations are prohibited. Only valid when operated from the CN591.)																																				
OFF	ON	OFF	ON/OFF Prohibited/Allowed mode 2 (level input)	On when CN591 No. 1 and No. 2 are closed, off when open. Manual operations prohibited when No. 1 and No. 3 are closed, permitted when open. (Cannot be operated from the remote control when manual operations are prohibited. Only valid when operated from the CN591.)																																				
OFF	ON	ON	ON/OFF Prohibited/Allowed mode 3 (pulse input)	On when CN591 No. 1 and No. 2 are closed, off when No. 1 and No. 3 are closed. Manual operations prohibited when No. 1 and No. 4 are closed, and permitted when No. 1 and No. 5 are closed. (Same as when they are open.)																																				
ON	OFF	OFF	Coin timer mode 1 (for a no-voltage contact point a)	Permitted and on when CN591 No. 1 and No. 2 are closed, manual operations prohibited and off when open. (When permitted, the unit can be operated from the remote control.)																																				
ON	OFF	ON	Coin timer mode 2 (for a no-voltage contact point b)	Manual operations prohibited and off when CN591 No. 1 and No. 2 are closed, permitted and on when open. (When permitted, the unit can be operated from the remote control.)																																				
ON	ON	OFF	Cooling-Heating/Temperature settings mode 1 (3 temperature patterns)	On when CN591 No. 1 and No. 2 are closed, off when open. When No. 1 and No. 3 are closed 20 °C When No. 1 and No. 4 are closed 24 °C When No. 1 and No. 5 are closed 28 °C (When multiple switches No. 3, 4, and 5 are closed, the highest temperature will be selected.) Heat when No. 1 and No. 6 are closed, cool when open. (Remote control operations are valid as always.)																																				
ON	ON	ON	Cooling-Heating/Temperature settings mode 2 (8 temperature patterns)	On when CN591 No. 1 and No. 2 are closed, off when open. <table border="1" style="margin-left: 20px;"> <thead> <tr> <th>No. 1 and No. 3</th> <th>No. 4</th> <th>No. 5</th> <th>Temperature settings</th> </tr> </thead> <tbody> <tr> <td>Open</td> <td>Open</td> <td>Open</td> <td>16 °C</td> </tr> <tr> <td>Closed</td> <td>Open</td> <td>Open</td> <td>18 °C</td> </tr> <tr> <td>Open</td> <td>Closed</td> <td>Open</td> <td>20 °C</td> </tr> <tr> <td>Closed</td> <td>Closed</td> <td>Open</td> <td>22 °C</td> </tr> <tr> <td>Open</td> <td>Open</td> <td>Closed</td> <td>24 °C</td> </tr> <tr> <td>Closed</td> <td>Open</td> <td>Closed</td> <td>26 °C</td> </tr> <tr> <td>Open</td> <td>Closed</td> <td>Closed</td> <td>28 °C</td> </tr> <tr> <td>Closed</td> <td>Closed</td> <td>Closed</td> <td>30 °C</td> </tr> </tbody> </table> Heat when No. 1 and No. 6 are closed, cool when open. (Remote control operations are valid as always.)	No. 1 and No. 3	No. 4	No. 5	Temperature settings	Open	Open	Open	16 °C	Closed	Open	Open	18 °C	Open	Closed	Open	20 °C	Closed	Closed	Open	22 °C	Open	Open	Closed	24 °C	Closed	Open	Closed	26 °C	Open	Closed	Closed	28 °C	Closed	Closed	Closed	30 °C
No. 1 and No. 3	No. 4	No. 5	Temperature settings																																					
Open	Open	Open	16 °C																																					
Closed	Open	Open	18 °C																																					
Open	Closed	Open	20 °C																																					
Closed	Closed	Open	22 °C																																					
Open	Open	Closed	24 °C																																					
Closed	Open	Closed	26 °C																																					
Open	Closed	Closed	28 °C																																					
Closed	Closed	Closed	30 °C																																					

■ SW501: Settings when connecting an MA remote controller

SW No.	Functions	OFF	ON	Comments	
No. 1	 Refrigerant address 0			Only specify these settings when connecting an MA remote controller.	
No. 2					
No. 3					
No. 4					 Refrigerant address 1
					 Refrigerant address 2
					 Refrigerant address 3
					 Refrigerant address 4
					 Refrigerant address 5
					 Refrigerant address 6
					 Refrigerant address 7
					 Refrigerant address 8
					 Refrigerant address 9
					 Refrigerant address 10
					 Refrigerant address 11
					 Refrigerant address 12
	 Refrigerant address 13				
	 Refrigerant address 14				
	 Refrigerant address 15				
No. 5	Room temperature detector	Indoor unit	Remote control	This should normally be set to OFF.	
No. 6	MA remote controllers are directly connected to indoor units within the same group.	Not mixed	Mixed		









## ■ SW502 : Air Conditioner Function Settings

(Set this switch based on the functions of the M series connected to this device.)

### M series

SW No.	Functions	OFF	ON	Comments
No. 1	Availability of a heating mode	Combined cooler and heater	Cooling unit only	
No. 2	Not in use	–	–	Permanently set to ON.
No. 3	Not in use	–	–	Permanently set to ON.
No. 4	Not in use	–	–	Permanently set to ON.
No. 5	Not in use	–	–	Permanently set to OFF.
No. 6	Not in use	–	–	Permanently set to OFF.
No. 7	Not in use	–	–	Permanently set to OFF.
No. 8	Availability of a fan (Cooling model only)	Has a fan or mode OFF	No fan or mode ON	

### P/S series

SW No.	Functions	OFF	ON	Comments												
No.1	Cooling only type/Heat pump type	Heat pump type	Cooling only type	Set the mode in accordance with the operation manual for the indoor unit.												
No.2	Auto mode	Not available (setting No. 3 disabled)	Available (setting No. 3 enabled)	Heat pump type : Set to ON. Cooling only type : Set to OFF.												
No.3		Available (unit)	Available (remote controller)	Set to OFF.												
No.4	Fan speed	4 speeds	3 speeds (2-speed model set ON)	When operating a 2-speed model with the 3-speed setting (ON), the MA remote controller display will indicate 3 fan speeds. The table below shows the displays and the actual outputs at that time. <table border="1" style="margin-left: 20px;"> <thead> <tr> <th>Display</th> <th>Meaning</th> <th>Indoor unit output</th> </tr> </thead> <tbody> <tr> <td></td> <td>Low speed</td> <td>Low speed</td> </tr> <tr> <td></td> <td>Medium speed</td> <td>High speed</td> </tr> <tr> <td></td> <td>High speed</td> <td>High speed</td> </tr> </tbody> </table>	Display	Meaning	Indoor unit output		Low speed	Low speed		Medium speed	High speed		High speed	High speed
Display	Meaning	Indoor unit output														
	Low speed	Low speed														
	Medium speed	High speed														
	High speed	High speed														
No.5	Vane	Available	Not available	The Vane function of either of indoor unit : When the function is provided, it is Available (OFF). When the function is not provided it is Not available (ON).												
No.6	Swing	Available	Not available	The Swing function of either of indoor unit : When the function is provided, it is Available (OFF). When the function is not provided, it is Not available (ON).												
No.7	Not in use	–	–	Permanently set to OFF.												
No.8	Fan mode	Not available	Available	Set to ON.												

\* Fan speed 2 step model : An actual fan speed is 2 step though the display of remote controller becomes 4 step or 3 step.

## 6. Test Run (Check Operations)

### ■ Interface status monitor

You can check the status of the interface by the LED lamp on the interface unit board.

LED lamp no.	Lamp off	Lamp on	Blinking
LED521	DC 12 V is not being supplied from the air conditioner.	DC 12 V is being supplied from the air conditioner.	–
LED522	Device is not communicating properly with the air conditioner.	–	Blinking at approx. 1 second intervals: Device is communicating normally with the air conditioner.
LED523	Device is not communicating properly with the MA remote controller.	–	Blinking at approx. 8 second intervals: Device is communicating normally with the MA remote controller.

\* Use the table above to check the device operations.

## 7. Mounting the MA & CONTACT Terminal Interface Unit

When mounting the interface to the back-side dent of MFZ-KA model, be sure to apply insulation material to prevent condensation from forming.

The Interface unit should be placed in a location where the connecting cable from the interface can reach an indoor unit. The device will not function properly if the connecting cable is extended so the connecting cable should not be extended. Mount the interface unit securely to a pillar or wall using 2 or more screws.

### ■ When Using Wall Mounting Brackets ②

**1** Attach the wall mounting brackets ② to the interface unit ① using 2 mounting screws ③.

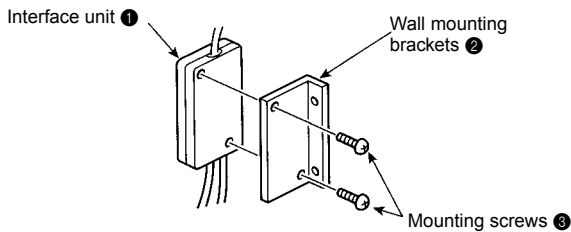

**2** Mount the unit to a pillar or wall using 2 mounting screws ③.

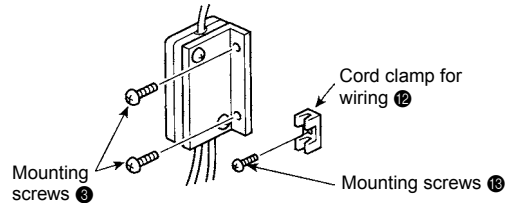

### ■ When Mounting Directly to a Wall

Mount the interface unit ① case to the wall using the mounting screws ③.

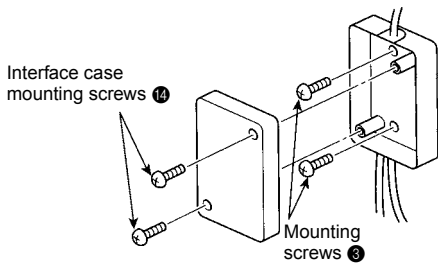

\* When mounting the interface unit ① using a cushioning material ④, be sure to mount it in a location where it will not fall.

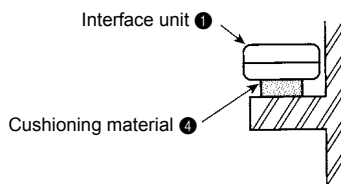

When mounting the interface unit ① inside a ceiling or wall, install an access door to facilitate maintenance.

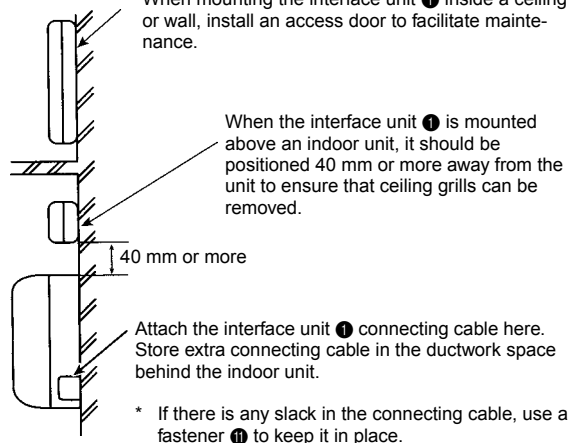

## 8. Specifications

Input voltage	12 V ---
Power consumption	2 W
Input current	0.15 A

This product is designed and intended for use in the residential, commercial and light-industrial environment.

The product at hand is based on the following EU regulations:

- Low Voltage Directive 73/23/EEC
- Electromagnetic Compatibility Directive 89/336/EEC

 **MITSUBISHI ELECTRIC CORPORATION**  
HEAD OFFICE: TOKYO BLDG., 2-7-3, MARUNOUCHI, CHIYODA-KU, TOKYO 100-8310, JAPAN

---