

# AIR PURIFIER

MODEL

# MA-E100R-E

## INSTRUCTION MANUAL



## Table of Contents

	Page	
● Features .....	2	Before Use
● Tips on Use .....	3	
● Safety Precautions .....	4	
● Attentions .....	6	
● Installation .....	7	
● Names and Functions of Parts .....	8	
● Main Unit   ● Control Panel		
● Preparation .....	10	
<hr/>		
● Operation .....	11	Operation
● About i-see Sensor, AUTO TURN, and Louvre .....	12	
● Detailed Knowledge .....	14	
<hr/>		
● Cleaning		Maintenance
● When Dirty .....	14	
● Approximately Once a Month .....	15	
● Approximately Once Every Six Months .....	16	
● When There is an Odor Coming Out of the Air Outlet .....	16	
● Replacement of Filters and Disposal ...	17	
<hr/>		
● Troubleshooting .....	18	Troubleshooting
● Specifications .....	20	

- Before use, please read this instruction manual carefully to ensure proper and safe use.
- Make sure you receive the warranty card from your dealer and ensure that it contains all the information such as your purchase date and the name of the dealer, etc.
- Please keep the instruction manual and warranty card.

# Features

## i-see Sensor and AUTO TURN Ensure that the Air Around People and All Over the Room is Purified. The Air Purifier Actively Purifies Air by Moving Itself.

### ● i-see Sensor P.12-13

i-see Sensor detects a person's location while turning left and right.

### ● AUTO TURN P.12-13

The air inlet and outlet are moved to the optimal direction depending on a person's location.

### ● Support for PM2.5

#### Catches 99%\* of particles from 0.1 to 2.5 μm.

Consideration is not given to new particles entering from outdoors due to, for example, ventilation.

● PM2.5 is a generic term for fine particulate matter of 2.5 μm or less.

● The removal of fine particulate matter less than 0.1 μm with this air purifier has not been verified.

Also, this air purifier is not capable of removing all harmful substances from the air.

● This is the effect achieved in a 30-m<sup>3</sup> enclosed space, and is not the result of verification in a space that is in actual use.

\* <Testing laboratory> SHANGHAI ENTRY-EXIT INSPECTION AND QUARANTINE BUREAU MECHANICAL & ELECTRICAL PRODUCTS TESTING CENTER

<Test method> Performed by regulating the initial concentration of particulate matter within the range of (5.0 ± 1.0) mg/m<sup>3</sup> in a 30-m<sup>3</sup> test space

<Test results> 99% eliminated in 20 minutes

### ● Two-layer HEPA Filter

Comes equipped with a HEPA filter that catches 99.97% of 0.3-μm pollen and house dust.

### ● Reduction of Airborne Viruses\*

\* This is the effect on airborne viruses achieved after operation for 11 minutes in a test space of a 25 m<sup>3</sup>, and is not the result of verification in a space that is in actual use.

Manual operation (High) (600 m<sup>3</sup>/h)

<Testing body> Virus Research Center, Sendai Medical Center, National Hospital Organization

<Test method> The performance evaluation test of the voluntary standard (JEM1467) issued by The Japan Electrical Manufacturers' Association was performed in a 25-m<sup>3</sup> test space.

<Test object> 1 type of airborne virus

<Test result> 99% reduction in 11 minutes

## Frequently Asked Questions

### What will happen if cleaning is not performed?

If a lot of dust adheres to the pre-filter and HEPA filter, performance may deteriorate remarkably.

### Will all cigarette smoke be removed?

The air purifier can remove nicotine and other particles, but the room needs to be ventilated occasionally because carbon monoxide (CO), a harmful substance contained in cigarette smoke, cannot be removed. Furthermore, when a lot of cigarettes are smoked, cigarette odor may be emitted from the unit.

# Tips on Use

## Recommended operations for various situations

Operation P.11

### For quick and powerful removal of contamination and odor from the air

<MANUAL>  
High

- Operation is performed with maximum air volume.
- A person is located by i-see Sensor and then efficient air flow is created by AUTO TURN.
- The louvre stops at the optimal angle. P.13

When smoking cigarettes, cleaning, and making beds

### For automatic removal of contamination and odor from the air

<AUTO>  
Normal

- This is the standard automatic operation. The air volume is changed automatically depending on the amount of contamination and odor.
- A person is located by i-see Sensor and then efficient air flow is created by AUTO TURN.
- The louvre angle changes according to the person's location.

### For quiet operation

<AUTO>  
Night

- Operation is performed automatically while keeping the air volume low.
- The control panel lamps, the clean monitors, and i-see Sensor lamp are dimmed slightly.
- i-see Sensor and AUTO TURN do not operate.
- The louvre stops at the optimal angle. P.13

When sleeping or a baby is in the room

<MANUAL>  
Low

- Operation is performed continuously with low air volume.
- A person is located by i-see Sensor and then efficient air flow is created by AUTO TURN.
- AUTO TURN turns the unit slowly and quietly compared with other operation modes.
- The louvre stops at the optimal angle. P.13

When sleeping or a baby is in the room

### For continuous operation

<MANUAL>  
Low  
Middle  
High

- Operation is performed continuously with a constant air volume.
- A person is located by i-see Sensor and then efficient air flow is created by AUTO TURN.
- The louvre stops at the optimal angle. P.13

# Safety Precautions

- To prevent personal injury, injury to others, or property damage, the following precautions must be observed.
- The following categories describe hazards caused by mishandling and their levels.
- The meanings of the graphic symbols used in this manual and on the unit are as follows.



## WARNING

Indicates a hazard caused by mishandling that may result in death or serious injury.



## CAUTION

Indicates a hazard caused by mishandling that may result in a minor injury or damage to the home and its contents.



Prohibited



Beware of rotating device



Do not disassemble



Do not use near water



Observe instructions

# WARNING



**Do not use a damaged power cord and plug, or a loose power outlet.**

This may cause **electric shock, short circuit, or fire.**



**Do not damage the power cord and plug.**

Do not unnecessarily bend, pull, twist, or bind the power cord, place it close to a hot object, place a heavy object on it, trap it between objects, or modify it.

- If the power cord is damaged, it must be replaced by the manufacturer, its service agents, or a similarly qualified person to avoid hazards.

This may cause damage, resulting in **fire or electric shock.**

(Also take care that a pet does not bite the power cord.)



**Do not repair, disassemble, or modify the unit.**

This may cause **fire or electric shock.**  
For repairs, contact the retail store where you purchased the product.



**Do not put a wire, pole, other foreign object or a finger into an air inlet, outlet, rotating units or any other opening into the unit.**

This may cause **electric shock or injury.**



**Use a 220-240 V AC power outlet.**

Using other than a 220-240 V AC power outlet may cause **electric shock, short circuit, or fire.**



**Remove the power plug before cleaning. Also, do not remove the power plug with a wet hand.**

This may cause **electric shock or injury.**



**Remove dust from the power plug regularly.**

If dust accumulates, humidity, etc. may cause an insulation failure, resulting in **fire.**



**If the unit is operating abnormally or fails, stop using it immediately.**

- The unit does not operate when the power switch is turned ON.
- The unit, power cord, or plug is abnormally hot.
- There is an abnormal noise or vibration during operation.
- There is a burning smell.
- The operating sound is abnormally loud.
- Mounting screws are corroded or loose.
- The earth leakage circuit breaker trips frequently.
- There is another abnormality or failure.

Failure to do so may cause **fire, electric shock, or injury.**

Immediately turn OFF the power switch and disconnect the power plug, and then contact the retail store.

This appliance can be used by children aged from 8 years and above and persons with reduced physical, sensory or mental capabilities or lack of experience and knowledge if they have been given supervision or instruction concerning use of the appliance in a safe way and understand the hazards involved. Children shall not play with the appliance. Cleaning and user maintenance shall not be made by children without supervision.

# CAUTION



**Do not allow flammable gas to be sucked inside or use the unit where flammable gas accumulates.**  
(Factory, beauty salon, etc.)

This may cause **fire**.



**Do not use the unit in a location with the oily smoke of machine oil or other oil.**

This may cause cracking, resulting in **electric shock**.



**Do not place the unit close to flammable objects or objects lit with fire, such as cigarettes or incense sticks.**

This may cause a **fire**.



**Do not stand on, sit on, or lean on the unit, or place objects on it. Do not pull the louvre with your fingers. Do not place in an unstable location.**

This may cause the unit to topple or fall and cause **injury**.



**Do not wipe the unit with benzene or thinner or spray insecticide or other chemicals onto it.**

This may cause **electric shock, fire, or cracking and cause injury**.



**Do not operate the unit when using an insecticide that produces smoke.**

An accumulation of chemical components may be released from the air outlet, and **be harmful to health**.  
After using an insecticide, ventilate the area sufficiently prior to operating the unit.



**Do not move the unit except by holding the handles.**

This may cause the unit to topple and fall, or pinch fingers, causing **injury**.



**Do not install the unit where water may be spilt onto it or where there is a lot of humidity such as in a bathroom.**

This may cause **electric shock**.  
Should water or other liquid be spilt onto the unit, stop operation and remove the power plug, and then contact the retail store where you purchased the product.



**Do not lay the unit horizontally when removing a filter.**

This may cause dust to enter inside, resulting in **fire or electric shock**.

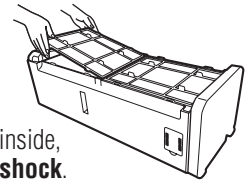

**Do not use a damaged filter or operate the unit while a filter is removed.**

This may cause dust to enter inside, resulting in **fire or electric shock**.

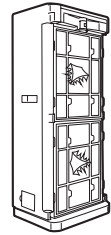

**Do not come close to the main unit while the unit is rotating.**

In particular take care regarding children.  
If you are sandwiched between the wall while rotating, it may cause an **injury**.



**Place the unit in a location where it will not bump into a wall or furniture while the unit is rotating.**

This may cause **damage** to the wall or furniture.



**Hold the bottom of the inlet panel when installing the inlet panel.**

If the top of the inlet panel is held, your hand can be trapped causing **injury**.



**When using the unit in combination with a combustion appliance, ventilate the room occasionally.**

Carbon monoxide cannot be removed from the air, so not ventilating the room may cause **carbon monoxide poisoning**.



**When disconnecting the power plug, pull it out straight while holding not the cord but the power plug.**

Failure to do so may cause **electric shock or a short circuit resulting in fire**.

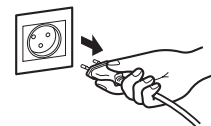

**When the unit will not be used for a long time, disconnect the power plug.**

Failure to do so may cause the insulation to deteriorate, resulting in **fire from a short circuit or an electric shock**.

# Attentions

This air purifier is designed for household use. Do not use it for commercial use.

Do not block the air inlet or outlet.

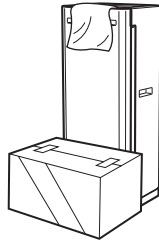

This may cause a malfunction.

Do not use this unit instead of an exhaust fan or exhaust hood (there is no ventilation function).

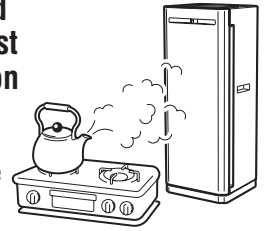

This may cause the filter life to become shorter and cause **deformation, discoloration, or malfunction.**

Do not insert a finger or foreign object into the PM2.5 Sensor.

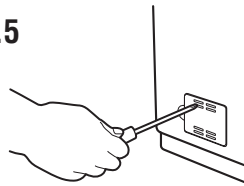

This may cause a malfunction.

Do not use the unit while it is laid horizontally.

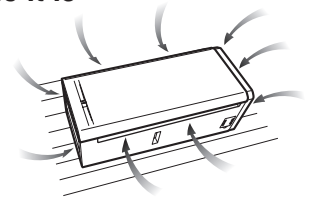

This may cause a malfunction.

Do not use the unit while the inlet panel, HEPA filter, activated charcoal filter is removed.

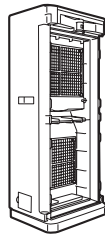

This may cause a malfunction.

Do not move the louvre, AUTO TURN, or i-see Sensor by hand.

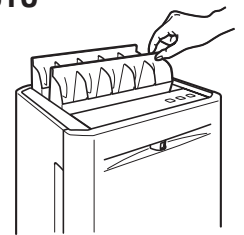

This may cause a malfunction.

Do not touch the i-see Sensor.

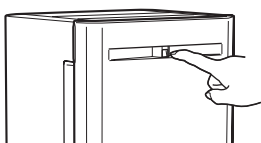

- This may cause a malfunction.
- If the i-see Sensor is soiled, it cannot detect correctly. If it is soiled, clean it in accordance with "Cleaning". P14

## ● WHEN MOVING THE MAIN UNIT

Turn OFF the power switch and disconnect the power plug, and then move the main unit by holding the two handles with both hands.

In some cases the blower fan makes a sound when the main unit is moved or tilted while it is operating.

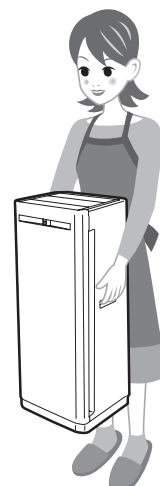

**Do not move the unit except by holding the handles.**

This may cause the unit to topple and fall, or pinch fingers, causing **injury.**

# Installation

## ● Before Installation

The air inlet, outlet, PM2.5 Sensor, and odor sensor are located as shown in the figure on the right. Take care regarding the following points.

Do not obstruct or place objects in front of the air inlet or outlet.  
→ The air purification function will be impaired.

Do not obstruct the odor sensor.  
→ It will not be possible to detect odors.

Do not obstruct the PM2.5 Sensor.  
→ It will not be possible to detect dirt.

This unit cannot be used hanging from a wall.

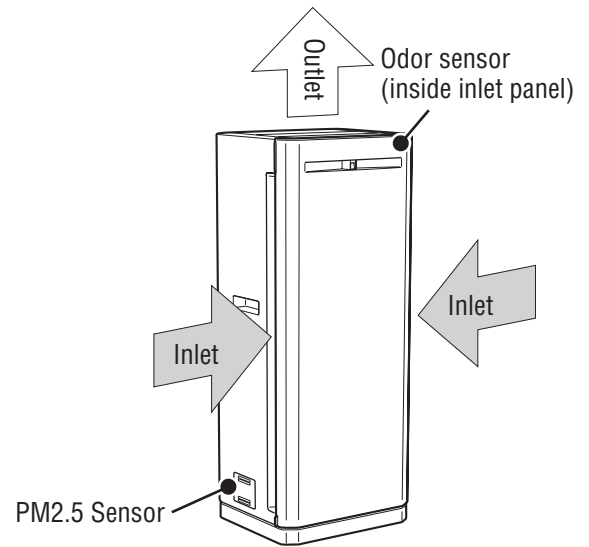

## ● Installation Procedure

### ● Install with space around this unit

- If this unit is installed in a place that is not level, or a place that is unstable (on a carpet or tatami mat, etc.), it may vibrate.
- The main unit is rotated by the AUTO TURN, so **install with 20 cm or more of space around this unit.**

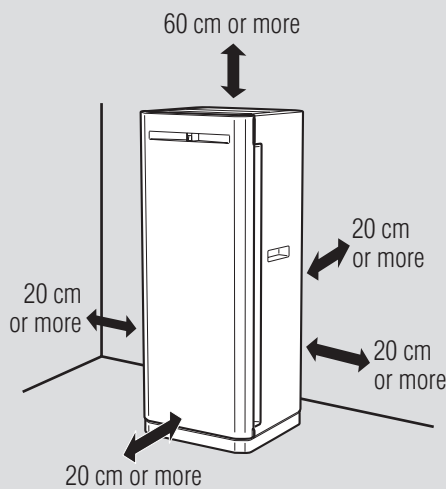

### ● Install in a location with good air circulation.

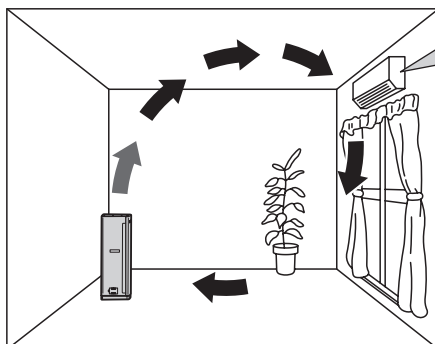

If installed facing an air-conditioner, the circulation effect is increased.

### ● Take care regarding the following points during installation.

Do not place hot items such as a stove near or on top of this unit.

This may cause a **malfunction, deformation, or discoloration.**

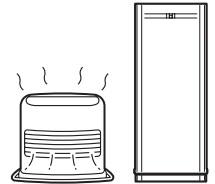

Do not use in a place subject to direct sunlight.

This may cause **deformation or discoloration.**

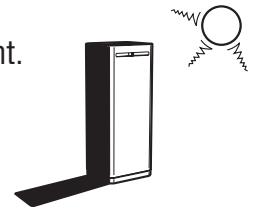

Install this unit 1 m or more away from television, cordless telephone, air conditioners, personal computers, fluorescent light fittings, etc.

This may cause **radio wave interference** with the other equipment.

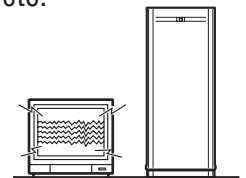

Do not place on soil or sand. Do not place on a floor with much soil or sand.

This may cause a **malfunction.**

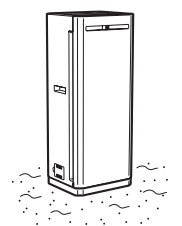



# Names and Functions of Parts

## Main Unit

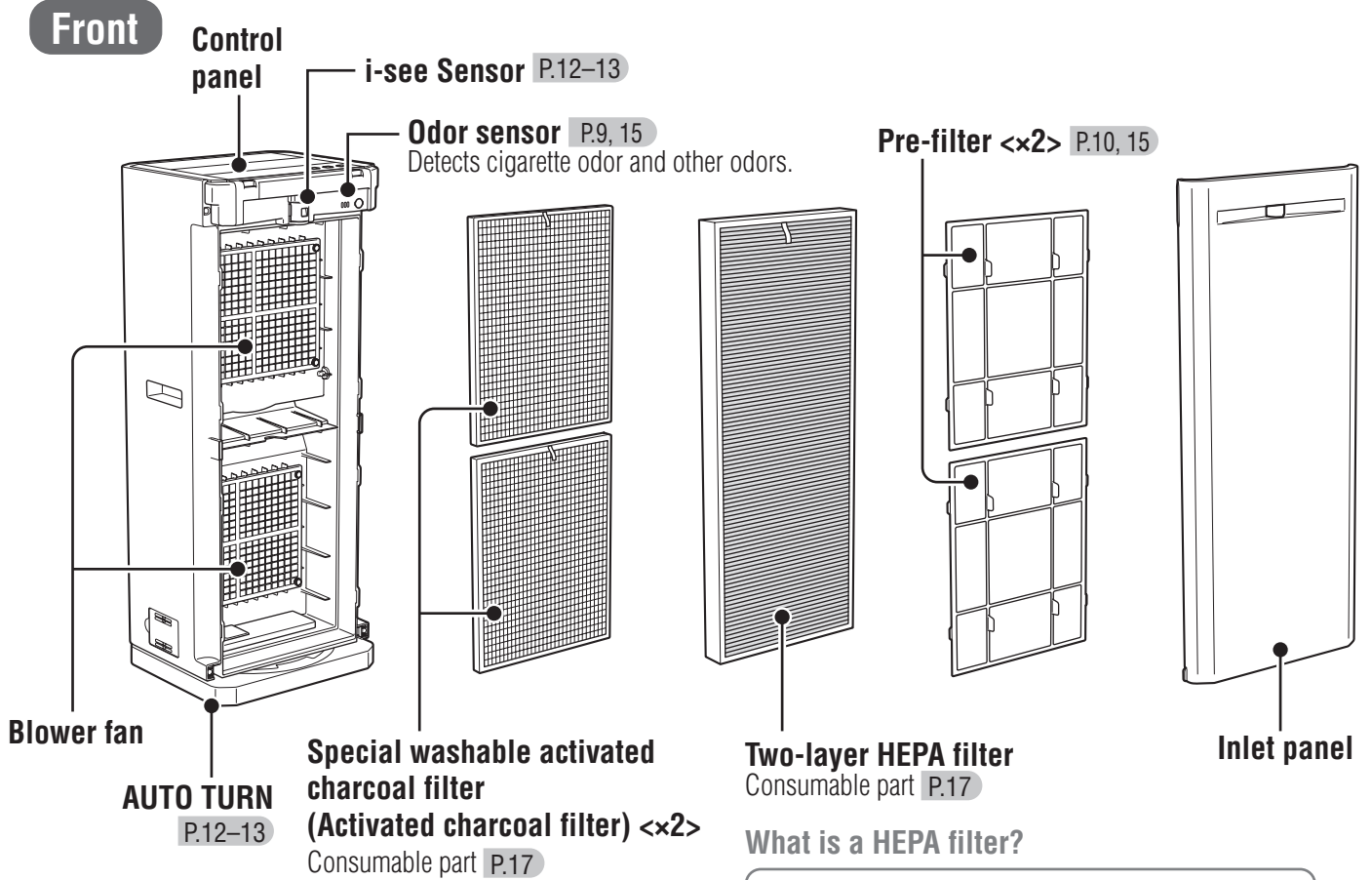

### What is a HEPA filter?

<High Efficiency Particulate Air filter>  
A highly efficient filter capable of filtering at least 99.97% of particles with a diameter of 0.3 μm (micrometer).

## Rear

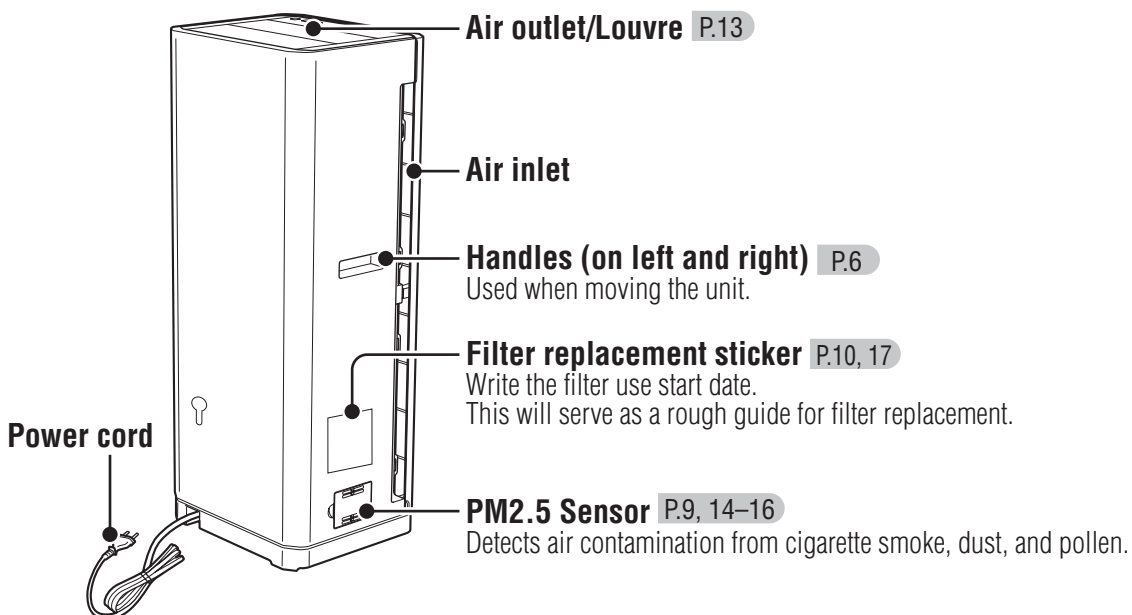



# Control Panel

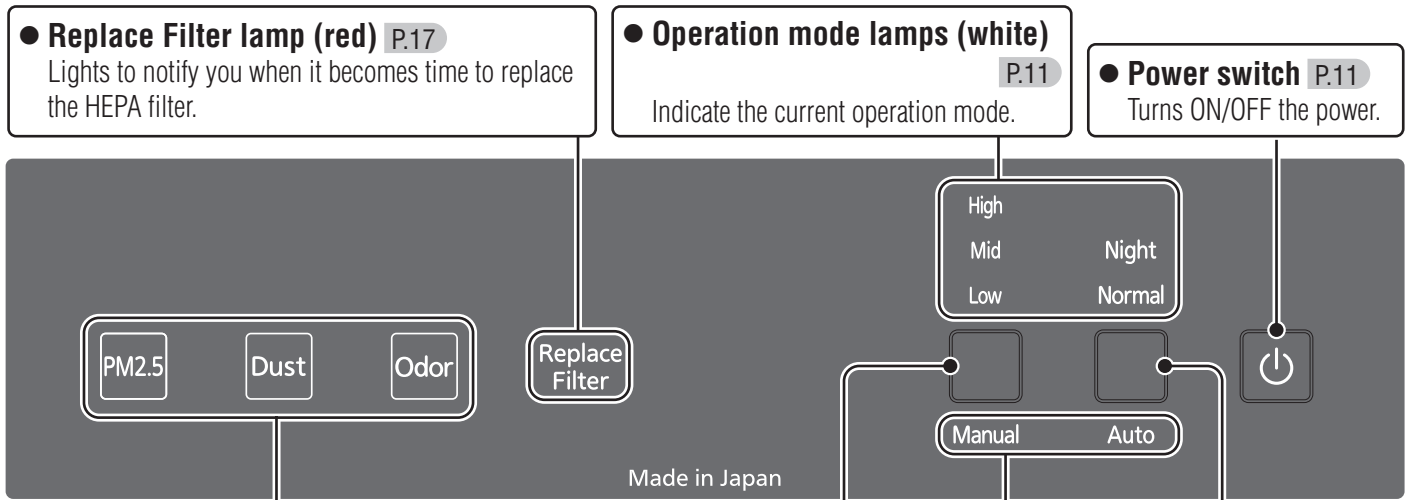

● **Replace Filter lamp (red)** P.17  
Lights to notify you when it becomes time to replace the HEPA filter.

● **Operation mode lamps (white)** P.11  
Indicate the current operation mode.

● **Power switch** P.11  
Turns ON/OFF the power.

● **Clean monitors (orange/red)**  
The state of air contamination detected with the odor sensor and PM2.5 Sensor is indicated by lamps lighting in three steps.  
<How to read the clean monitors>

● **Manual switch** P.11  
Switches the operation mode between Low, Middle, and High.

● **Auto switch** P.11  
Switches the operation mode between Normal and Night.

● **Operation switch lamps (white)** P.11  
Lights when the power switch is turned ON.

● **Reset button** P.17  
(The button is located at top right of the unit and accessible by removing the inlet panel.)  
Cancels the Replace Filter lamp.

● **i-see Sensor lamp (green/orange)**  
● Lights according to the clean monitors.  
(When clean monitor lamps are lit: Orange)  
(When clean monitor lamps are off: Green)  
● Flashes in green during the i-see Sensor detection operation.

**PM2.5 monitor**  
The state of air contamination from PM2.5 and other small particles is detected by the PM2.5 Sensor and then indicated.

**Dust monitor**  
The state of air contamination from pollen, dead bodies of mites, and other large particles is detected by the PM2.5 Sensor and then indicated.

**Odor monitor**  
The state of air contamination from cigarette odor and other odors is detected by the odor sensor and then indicated.

**PM2.5 Sensor**  
This optical sensor detects the number of particles.  
The monitor indications are divided into "PM2.5" and "Dust" according to the size of the particles.  
\* Particles less than 0.5 μm are not detected.

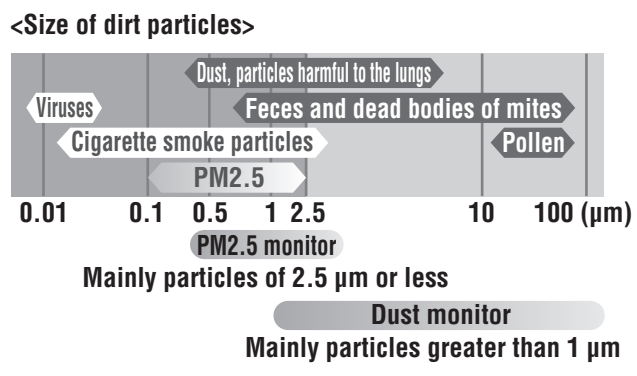

**Adjusting the Sensitivity of the PM2.5 Sensor** P.14

**Odor sensor**  
This semiconducting sensor detects odors and other gases. It also responds to wind from air conditioners, electric fans, and other appliances, odorless gases, and perfumes.

Before Use

# Preparation

Take the activated charcoal filter out of its plastic bag and then install it.

## 1 Remove the inlet panel.

Pull the inlet panel toward you while pressing the levers at the bottom.

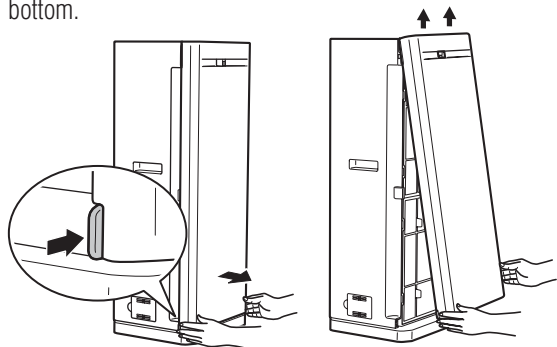

## 2 Remove the filters.

### ① Pre-filter (×2)

Remove the filter while holding the tabs.

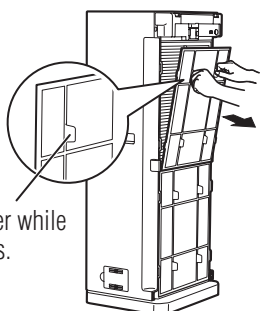

### ② HEPA filter

Remove the filter while holding the tab.

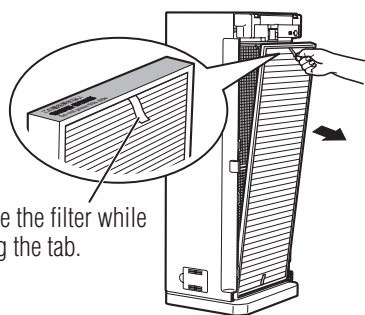

## 3 Remove the activated charcoal filters and then take them out of its plastic bag.

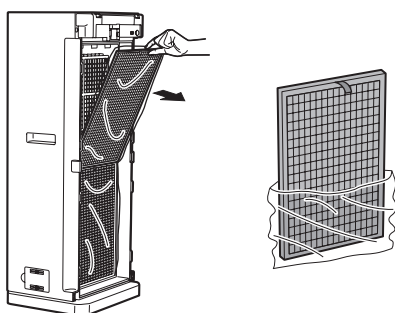

The distribution of charcoal may be uneven and there may be black charcoal powder in the plastic bag, but this will not affect the performance.

## 4 Attach the filters to the main unit.

### ① Activated charcoal filter (×2) Push the filter all the way in.

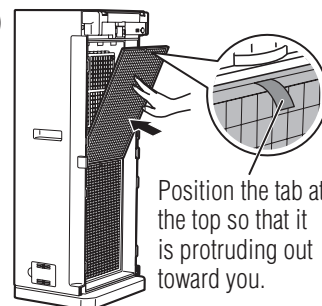

Position the tab at the top so that it is protruding out toward you.

### ② HEPA filter

Confirm the installation orientation and then push the filter all the way in.

Do not push this surface downward. This may cause deformation.

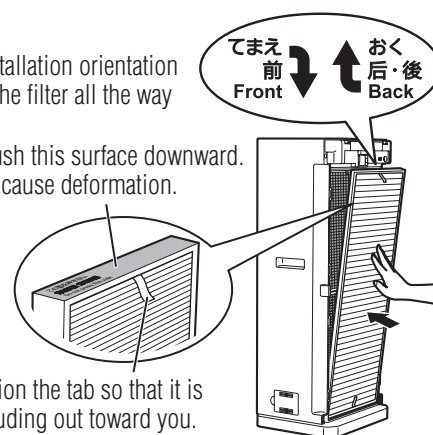

Position the tab so that it is protruding out toward you.

### ③ Pre-filter (×2)

Insert the eight tabs at the left and right of the filter into the eight holes in the main unit. (There is no top and bottom.)

Hole in the main unit

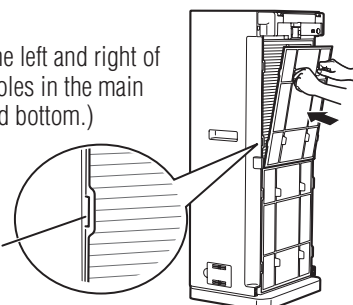

## 5 Attach the inlet panel to the main unit.

Align the inlet panel with both edges of the main unit and then hook the two tabs at the top of the inlet panel onto the main unit and firmly push in the bottom.

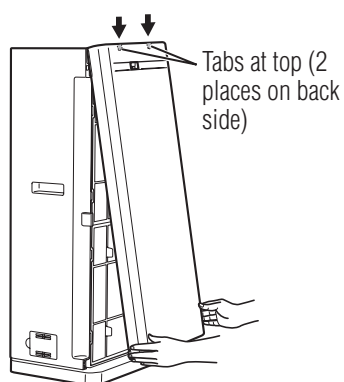

Tabs at top (2 places on back side)

Write the filter use start date on the filter replacement sticker on the right side of the main unit.

# Operation

Select from Manual operation (three air volume levels) and Auto operation (Normal and Night).

## 1 Insert the power plug into the power outlet.

When the power plug is inserted, the i-see Sensor operates and then stops when it faces forward. Furthermore, the main unit turns to face forward.

## 2 Start the operation.



- All of the lamps flash twice.
- Operation switch lamps light up.
- An operation mode lamp lights up.
- The louvre opens and blowing starts.

**Press**

### ATTENTION

Press the power switch after i-see Sensor and AUTO TURN stop. (If operation does not start after pressing the power switch, press it again.)

Response will be slow for a few minutes after the power switch is turned ON because the PM2.5 Sensor and odor sensor are performing the preparation operation.

## 3 Change the operation.

- For operation with a constant air volume (Manual)

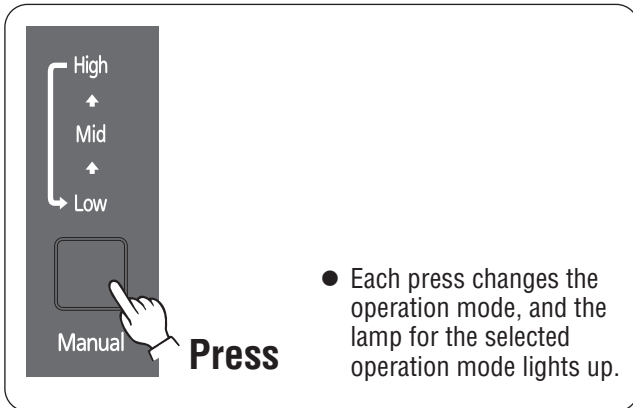

- Each press changes the operation mode, and the lamp for the selected operation mode lights up.

- For automatic operation according to level of contamination (Auto)

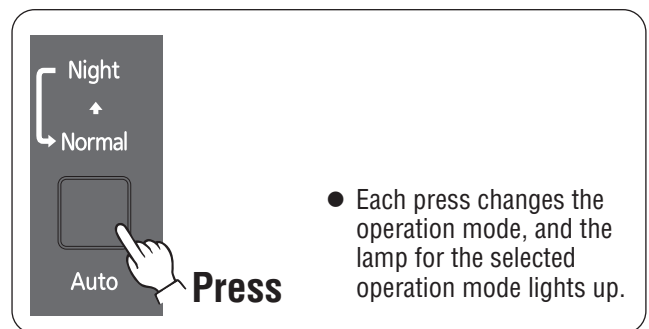

- Each press changes the operation mode, and the lamp for the selected operation mode lights up.

Before Use

Operation

### Air volume (Low/Middle/High)

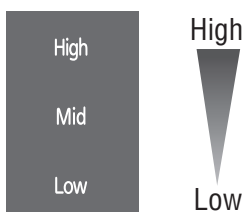

- A person is located by i-see Sensor and then efficient air flow is created by AUTO TURN.
- The louvre stops at the optimal angle.

### Normal

- This is the standard automatic operation. The air volume is changed automatically.
- A person is located by i-see Sensor and then efficient air flow is created by AUTO TURN.
- The louvre operates according to the person's location detected.

### Night

- Operation is performed automatically while keeping the air volume low.
- The control panel lamps and the clean monitors are dimmed slightly.
- The i-see Sensor and AUTO TURN do not operate.
- The louvre stops at the optimal angle.

### NOTE

When dust or odor is detected, the air volume and sound change.

## 4 End the operation.



- The operation switch lamps go out.
- The operation mode lamp goes out.
- The louvre closes.

**Press**

- The i-see Sensor and the main unit automatically face forward.
- The operation mode is remembered even if the power switch is turned OFF or the power plug is disconnected.

# About i-see Sensor, AUTO TURN,

## Features

The direction to a person's location is detected by the i-see Sensor. The air inlet and outlet are moved by the AUTO TURN and the optimal air flow is created by the louvre according to the person's location.

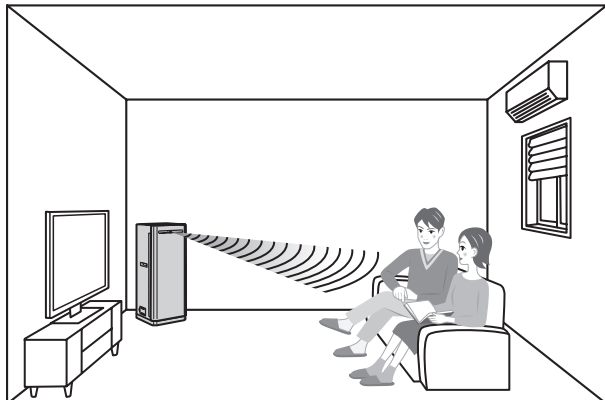

The i-see Sensor turns approx. 150 degrees in the left and right directions to detect the direction to a person's location.

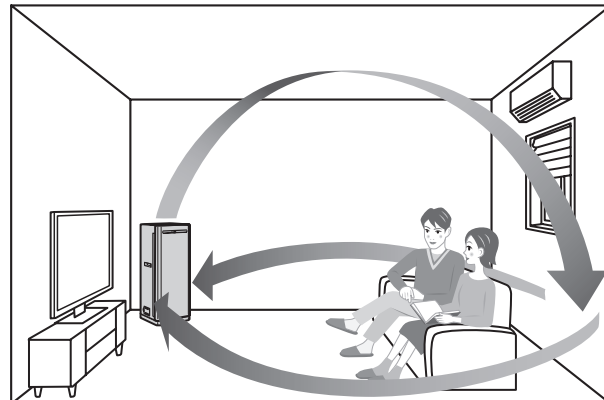

The air inlet and outlet are moved by the AUTO TURN which moves the main unit according to the person's location. The optimal air flow is created by the louvre in order to clean the area around the person.

## Operations (when Normal Operation Mode is Selected)

When operation is started, the i-see Sensor begins detection. The i-see Sensor turns left and right while the main unit remains facing forward. After completing one left and right movement (takes approx. two minutes), the i-see Sensor determines the direction to a person's location.

### <When a person is present>

- ① The main unit is turned toward the person's location automatically and then stopped by the AUTO TURN.
- ② The louvre controls the air-flow direction so that air does not blow directly at the person.
- ③ Contamination is monitored while removing the dust in the area around the person.
- ④ When contamination in the room is detected by the PM2.5 Sensor and odor sensor, the air volume is changed automatically.

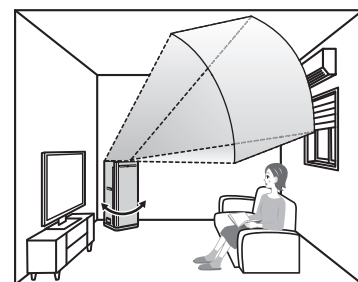
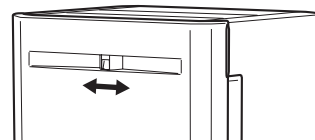

Air flow is controlled so that air is not blown directly at a person.

After approx. 15 minutes, the main unit is turned to face forward and then stopped by the AUTO TURN.

The i-see Sensor turns left and right again to detect the direction to a person's location.

- If more than one person is detected, the AUTO TURN stop position is determined automatically depending on the number of persons and the direction to the persons.

### <When a person is not present>

- ① The louvre controls the air-flow direction so that air is blown over the entire room while the main unit remains facing forward.
- ② Contamination is monitored while removing the dust in the entire room.
- ③ When contamination in the room is detected by the PM2.5 Sensor and odor sensor, the air volume is changed automatically.

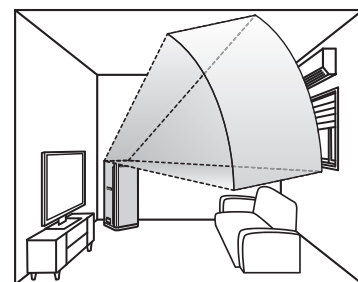

Air is blown over the entire room.

After approx. three minutes, the i-see Sensor turns left and right again to detect the direction to a person's location.

# and Louvre

## i-see Sensor detection

<Rough guide on detection area>  
(When room temperature is 24°C)

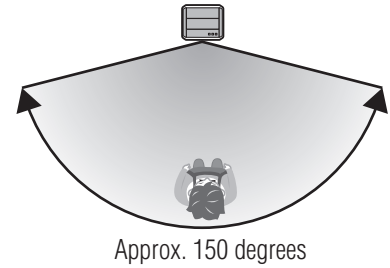
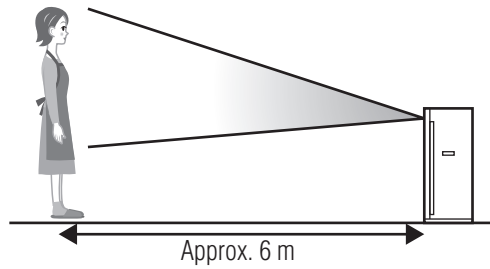

- The i-see Sensor detects a person's location within a range of approx. 150 degrees while turning left and right. (The i-see Sensor lamp flashes green while the i-see Sensor is performing the detection operation.)
- The i-see Sensor measures the indoor temperature in the room and determines the direction to a person's location from variations in the temperature.
- The i-see Sensor operates only when the main unit is stopped and faces forward. (The i-see Sensor does not operate when the AUTO TURN is operating or the main unit faces a direction other than the forward direction.)
- A person cannot be detected in locations such as the following.
  - Outside of the detection area
  - Where there is an obstacle (furniture or other object) to the main unit
- A person cannot be detected correctly in cases such as the following.
  - When there is something that changes the temperature significantly within a short period of time (e.g., television, air conditioner, refrigerator)
  - When the room temperature or the temperature of the floor and walls is high (rough guide: 30°C or more)
  - When the room temperature or the temperature of the floor and walls is low (rough guide: 8°C or less)
  - When skin is not exposed because the person is under a blanket or wearing a lot of clothes
  - When the heat source cannot be detected such as when there is a small child or pet or a person wearing a lot of clothes
  - When the distance to the person is short (rough guide: 0.5 m or less)
  - When the distance to the person is long (rough guide: 6 m or more)
  - When the person is not moving much

### <When the i-see Sensor cannot detect a person>

- When the i-see Sensor cannot detect a person and none of the above apply, perform the check described in the following procedure. (Perform the check when the room temperature is 15 to 28°C.)
  - ① Turn ON the power switch and stand in the position indicated by "A" in the figure on the right.
  - ② When the i-see Sensor turns right and passes you, move to the position indicated by "B" in the figure on the right.
    - Operation is normal if the main unit is moved to face you (position indicated by "B") by the AUTO TURN.

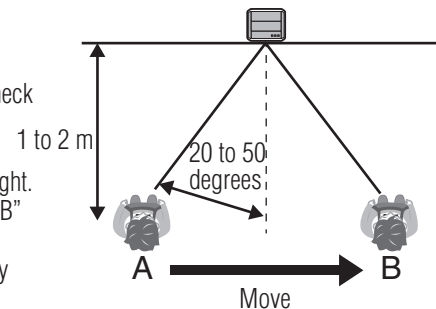

### <Turning off the i-see Sensor> P.14

### <AUTO TURN operation range>

The AUTO TURN automatically turns the main unit according to the person's location detected by the i-see Sensor. The main unit is stopped at any of ① to ⑤ in the figure on the right.

- The operation range is approx. 90 degrees. It differs from the detection range of the i-see Sensor.
- The main unit may not turn to face a person when, for example, the i-see Sensor has detected multiple persons.
- When the i-see Sensor detects a person directly in front of the main unit, the main unit is not moved and remains facing forward.
- The AUTO TURN will not operate when the main unit hits a wall or other object because at least 20 cm of space was not provided around it, when the main unit hits an object nearby that prevents turning, or when the main unit is restrained from moving.

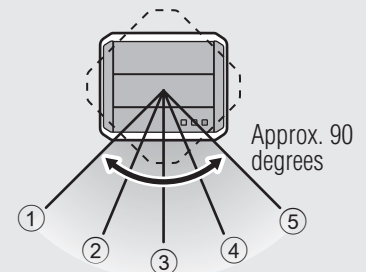

### <Louvre operation range>

The louvre is stopped at any of ① to ③ in the figure on the right.

- ① When a person is not detected by the i-see Sensor while Normal operation mode is selected
  - Air is blown all over the room including far away locations.
- ② When a person is detected by the i-see Sensor while Normal operation mode is selected
  - Air flow is controlled so that air is not blown directly at a person.
- ③ When manual operation is selected
  - Air flow is controlled so that sufficient air-flow volume is maintained.

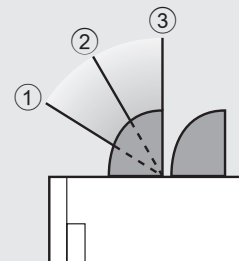

# Detailed Knowledge

# Cleaning

## Adjusting the Sensitivity of the PM2.5 Sensor

The sensitivity of the PM2.5 Sensor can be adjusted. Switch it when the clean monitor is reacting even though the air in the room is clean.

**Switch it when the operation is turned OFF.**

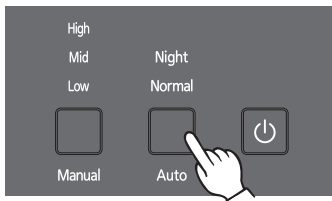

**Press the AUTO switch 3 times within 2 seconds**

- **When the PM2.5 Sensor switches to standard sensitivity**  
The unit makes a “blip” sound and the PM2.5 lamp flashes.
- **When the PM2.5 Sensor switches to high sensitivity**  
The unit makes a “blip blip” sound and the PM2.5 lamp lights up.



- \* The default sensitivity setting is high sensitivity.
- \* The settings are stored even when operation is turned OFF and the power plug is pulled out.

## Turning OFF the i-see Sensor and AUTO TURN

Set to OFF when the sound of the AUTO TURN is bothering you or when you want to clean the air regardless of the position of people.

**Set it when the operation is turned OFF.**

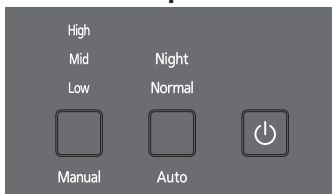

**Press the Manual switch 3 times within 2 seconds**

- **When the i-see Sensor and AUTO TURN are switched OFF**  
The unit makes a “blip” sound and the Dust lamp flashes.
- **When the i-see Sensor and AUTO TURN are switched ON**  
The unit makes a “blip blip” sound and the Dust lamp lights up.



- \* The default setting is ON.
- \* The settings are stored even when operation is turned OFF and the power plug is pulled out.

## Changing the orientation of the main unit (AUTO TURN)

The orientation of the main unit (AUTO TURN) can be changed as desired.

**Set it when the operation is turned ON.**

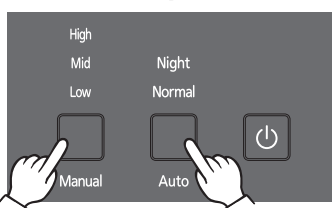

**Press the Manual switch and the Auto switch simultaneously for 3 seconds or more**

**While pressing continuously, the AUTO TURN rotates. When the unit has rotated to your preferred position, take your fingers from the switches.**

- \* After setting the position, the i-see Sensor and AUTO TURN do not operate.
- \* When operation is turned OFF, the setting is deleted.

Perform periodic care and cleaning to maintain the performance of this unit. Perform care and cleaning after turning OFF the power switch, pulling out the power plug, and checking that the blower fan has stopped.

## When Dirty

### Main Unit

**Wipe with a soft cloth.**

When the unit is very dirty, wipe it with a damp cloth.



### i-see Sensor

**Gently wipe with a dry cotton bud.**

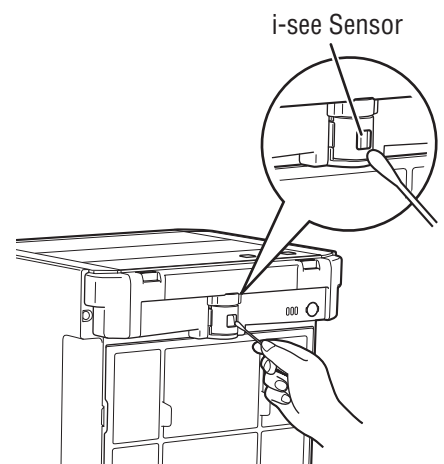

Do not wipe with water, alcohol, cleaning agent, etc. This may cause a malfunction.



Do not use detergent, scouring powder, chemically-treated cleaning cloth, gasoline, benzene, thinner, etc. This may damage the main unit.



**WARNING**

**Remove the power plug before cleaning.**  
This may cause electric shock or injury.

## Approximately Once a Month

### HEPA filter, Pre-filter

**1 Remove the inlet panel.** P.10

**2 Remove and clean the pre-filters (x2).**

Suck up the dust with a vacuum cleaner using a nozzle with a brush.

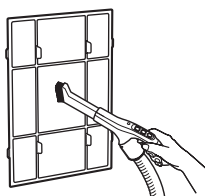

<When the dirt is severe>  
Wash with water using a soft sponge, etc., and dry thoroughly.

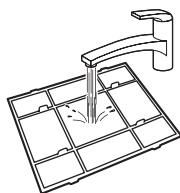

**3 Clean the HEPA filter.**

Suck up the dust with a vacuum cleaner using a nozzle with a brush.

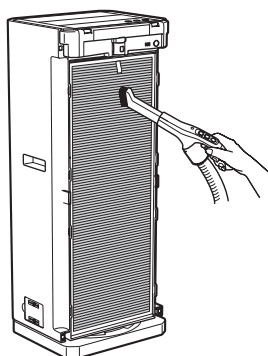

- The material on the reverse side of the HEPA filter is weak, so do not apply suction to it with a vacuum cleaner.
- Do not wash it with water.

**4 Install the pre-filters and inlet panel onto the main unit.** P.10

### Odor sensor, PM2.5 Sensor

**1 Remove the inlet panel.** P.10

**2 Suck up the dust with a vacuum cleaner using a nozzle.**

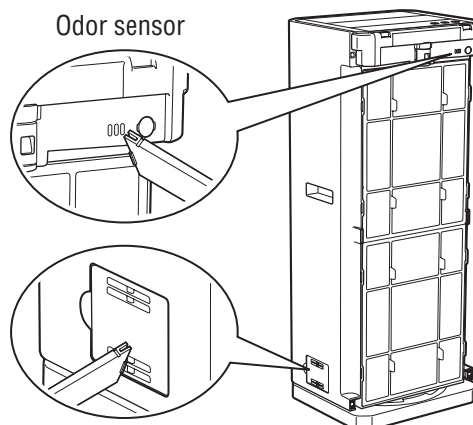

PM2.5 Sensor  
Located on the right side of the main unit.

**3 Attach the inlet panel to the main unit.** P.10



## Cleaning (Cont.)

### Approximately Once Every Six Months

#### Lens of PM2.5 Sensor

- 1 Remove the cover of the PM2.5 Sensor.**

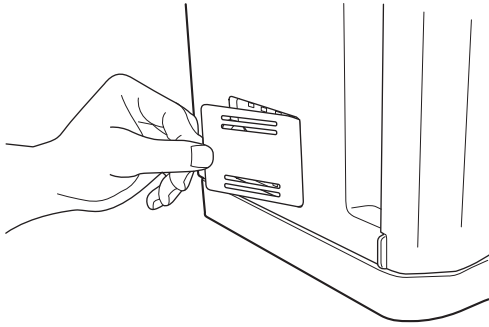

- 2 Clean the lens with a dry cotton swab.**

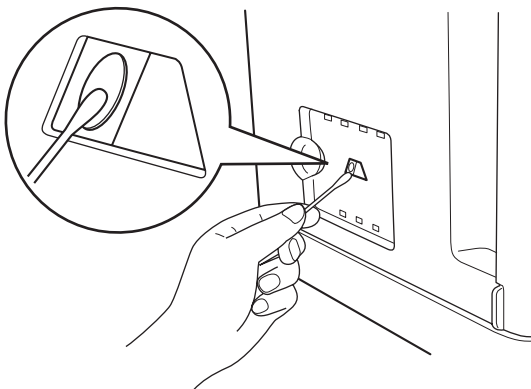

Do not use water, alcohol, detergent, etc.  
This may cause a malfunction.

- 3 Attach the cover of the PM2.5 Sensor.**

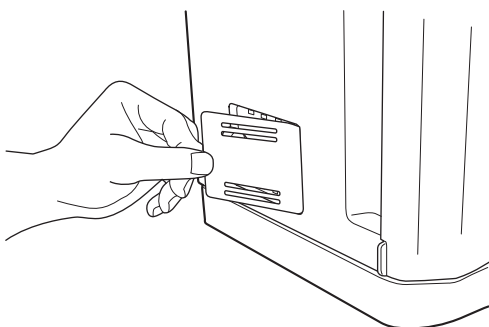

### When There is an Odor Coming Out of the Air Outlet

#### Activated charcoal filter

- 1 Remove the inlet panel, pre-filter, and HEPA filter.** P.10

- 2 Remove the activate charcoal filter.** P.10

- 3 Soak and wash the activated charcoal filter.**

Soak in cold or lukewarm water for approximately one hour and then wash in water.

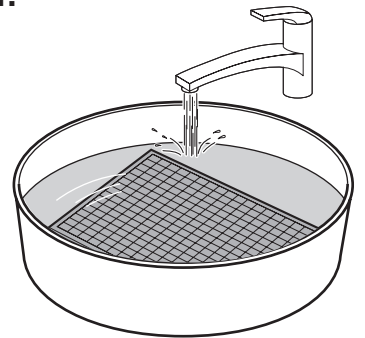

Do not use detergent. Also, do not scrub it.  
This may cause the activated charcoal filter to become damaged.

- 4 Allow the activated charcoal filter to dry.**

Allow them to dry properly in a well-ventilated place in the shade for approximately six hours (the drying time differs depending on the season and climate).

- Do not use them while they are still wet.  
Water drops may be blown from the air outlet and an odor may be created.
- Soaking and washing will not completely restore the deodorizing performance of the activated charcoal filter. Replace this filter when the time for replacement is reached.

- 5 Attach the activated charcoal filter to the main unit.** P.8

- 6 Attach the HEPA filter, pre-filter, and inlet panel to the main unit.** P.8

# Replacement of Filters and Disposal

Replace the filters with new ones when the time for replacement is reached.

## Replacing the HEPA filter and activated charcoal filter

Rough guide on replacement timing

- When the Replace Filter lamp lights up  
The lamp lights up after approximately 4.5 years with "Low" operation or approximately 8 months with "High" operation.
- When the HEPA filter becomes very dirty and omits bad odors
- When odors cannot be removed from the activated charcoal filter after soaking and washing it

Turn OFF the power switch, disconnect the power plug, and check that the blower fan is stopped before replacing filters.

**1** Remove the HEPA filter and activated charcoal filter and then install new ones. P.10

**2** Insert the power plug and then reset the Replace Filter lamp.

Press until you hear the "blip, blip blip" sounds (approx. 3 seconds).

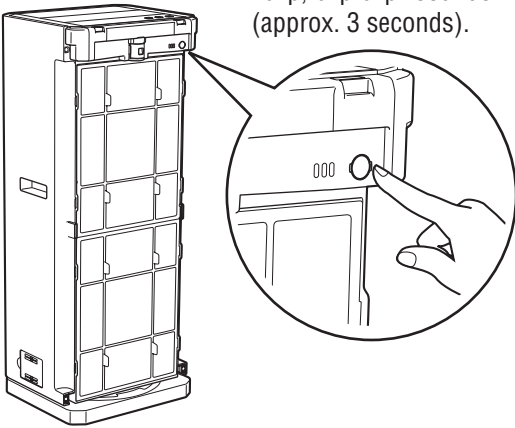

- The Replace Filter lamp goes out. (The lamp is reset.)

- **The life of the HEPA filter and activated charcoal filter differs depending on operating environment and conditions of use.**
- When replacing the HEPA filter, also replace the activated charcoal filter at the same time.
- **The HEPA filter cannot be reused even if it is washed.** When it becomes dirty, be sure to replace it with a new one.
- In the following cases, odors may adhere to the HEPA filter and main unit. Clean the main unit and replace the HEPA filter.
  - When a lot of cigarettes are smoked
  - When there are a lot of odors in the room

## Consumable parts

### ● Replacement filter set

- Two-layer HEPA filter
- Special washable activated charcoal filter (x2)
  - Model MAPR-865HFT
  - Model code 5D4 820

Purchase from the retail store where you purchased the product.

### <When you wish to purchase a filter separately>

When only one of the filters is dirty or damaged or odor cannot be removed from it

### ● Replacement two-layer HEPA filter

- Service part number M25 409 349

### ● Replacement special washable activated charcoal filter (x2)

- Service part number M25 409 349K

Purchase from the retail store where you purchased the product.

\* The sales channels differ so the price of just one filter is relatively high.

## Disposal

Dispose of the filters and main unit in accordance with the local regulations on disposal.

### ● HEPA filter

Materials: PP (polypropylene), rayon, and PET (polyethylene terephthalate)

### ● Activated charcoal filter

Materials: Activated charcoal, PET (polyethylene terephthalate), and PS (polystyrene)

### ● Main unit

Dispose of the main unit in accordance with the local regulations on disposal without disassembling it.

# Troubleshooting

Before requesting repairs, thoroughly read this Instruction Manual, and check the following points.

Symptom	Cause and Remedy
The air purifier does not operate.	<ul style="list-style-type: none"> <li>● Has the power plug become disconnected? → Firmly insert the power plug into the power outlet. <b>P.11</b></li> <li>● Is an operation mode lamp lit? (Is the power switch ON?) → Turn ON the power switch. <b>P.11</b></li> </ul>
The main unit vibrates a lot.	<ul style="list-style-type: none"> <li>● Did you install the main unit on a surface that is not flat or stable? → Install the main unit on a table or other surface that is flat and stable. <b>P.7</b></li> </ul>
Odor and smoke are difficult to remove.	<ul style="list-style-type: none"> <li>● Is the pre-filter dirty? → Clean the pre-filter. <b>P.15</b></li> <li>● Are the filters dirty? → Replace the filters. <b>P.17</b></li> <li>● Is there dust on the PM2.5 Sensor and odor sensor? → Clean the PM2.5 Sensor and odor sensor. <b>P.15-16</b></li> </ul>
AUTO TURN does not move.	<ul style="list-style-type: none"> <li>● Are the i-see Sensor and AUTO TURN set to OFF? → Set them to ON. <b>P.14</b></li> <li>● Is the unit being operated in the Auto operation "Night"? → The i-see Sensor and AUTO TURN do not operate in the Auto operation "Night". Operate the unit in a mode other than Auto operation "Night". <b>P.11</b></li> </ul>
<ul style="list-style-type: none"> <li>● Unit does not face to the front</li> <li>● The position of the front deviates from the standard</li> </ul>	<ul style="list-style-type: none"> <li>● Is there an object within the range of rotation of the main unit? → Install the main unit with 20 cm or more of empty space around it, then press the power switch again to turn the operation ON. <b>P.7, 11</b></li> </ul>
The unit does not face towards the direction where there is a person. (i-see Sensor does not detect the presence of a person)	<ul style="list-style-type: none"> <li>● Are the i-see Sensor and AUTO TURN set to OFF? → Set them to ON. <b>P.14</b></li> <li>● Is the room temperature high? → When the room temperature is high, a person may not be correctly detected. <b>P.13</b></li> <li>● Is there an obstruction (furniture, etc.) between the main unit and the person? → If there is an obstruction (furniture, etc.) between the main unit and the person, the person cannot be correctly detected. <b>P.13</b></li> <li>● Is the unit being operated in the Auto operation "Night"? → The i-see Sensor and AUTO TURN do not operate in the Auto operation "Night". Operate the unit in a mode other than Auto operation "Night". <b>P.11</b></li> <li>● Refer to &lt;When the i-see Sensor cannot detect a person&gt;. <b>P.13</b></li> </ul>
The unit faces towards a direction where there is no person.	<ul style="list-style-type: none"> <li>● The i-see Sensor may erroneously detect heat from television, air conditioner, refrigerator, etc., and cannot correctly detect a person. <b>P.13</b></li> </ul>
There are strong operational noise or vibrations.	<ul style="list-style-type: none"> <li>● Is the unit being operated in the Manual operation "High"? → The sound is louder for operation with a high air volume. If the sound bothers you, select an operation mode with a low air volume. <b>P.11</b></li> <li>● Is the pre-filter dirty? → Clean the pre-filter. <b>P.15</b></li> <li>● Are the filters dirty? → Replace the filters. <b>P.17</b></li> <li>● Is the activated charcoal filter installed in the main unit still inside the plastic bag? → Take it out of its plastic bag and then attach it again. <b>P.10</b></li> </ul>

Symptom	Cause and Remedy
There is a “ticking” sound.	<ul style="list-style-type: none"> <li>● This is the sound of the AUTO TURN rocking. Install the main unit with 20 cm or more of empty space around it, then press the power switch again to turn the operation ON. <b>P.7, 11</b></li> </ul>
There is a “whin-whin” “ku ku” sound.	<ul style="list-style-type: none"> <li>● This is the sound when the i-see Sensor moves left and right. It is not abnormal.</li> </ul>
There is a “boon” sound.	<ul style="list-style-type: none"> <li>● This is the sound when the AUTO TURN operates. It is not abnormal. If it bothers you, turn the AUTO TURN OFF. <b>P.14</b></li> </ul>
The main unit makes a sound when being moved.	<ul style="list-style-type: none"> <li>● Are you moving the air purifier while it is operating? → If the main unit is suddenly moved or tilted, sound may be emitted. <b>P.6</b></li> </ul>
When the power plug is disconnected, sometimes a bleep or buzzing sound can be heard.	<ul style="list-style-type: none"> <li>● Did you disconnect the power plug while the power switch is ON? → Turn OFF the power switch before disconnecting the power plug.</li> </ul>
When looked through the air outlet during operation, the blower fan is vibrating.	<ul style="list-style-type: none"> <li>● This is not a problem as long as there is no abnormal noise or abnormal vibration.</li> </ul>
<b>Clean monitor</b>	<ul style="list-style-type: none"> <li>● If the room is large, the air may take a while to become clean.</li> <li>● If there is a lot of dust and odor, the air may take a while to become clean.</li> <li>● Perform “Adjusting the Sensitivity of the PM2.5 Sensor” to see if it helps. <b>P.14</b></li> </ul> <p>&lt;How to check monitor operation&gt;</p> <ul style="list-style-type: none"> <li>● Rub tissue paper near the PM2.5 Sensor so as to create dust.</li> <li>● Place perfume, hair tonic, or the like on tissue paper and then place the tissue paper in front of the main unit so that the fragrance is sucked into it.</li> </ul>
	<ul style="list-style-type: none"> <li>● The monitors respond very infrequently.</li> <li>● Is there dust on the PM2.5 Sensor and odor sensor? → Clean the PM2.5 Sensor and odor sensor. <b>P.15-16</b></li> <li>● Response will be slow for a few minutes after the power switch is turned ON because the PM2.5 Sensor and odor sensor are performing the preparation operation. <b>P.11</b></li> <li>● Is the PM2.5 Sensor on standard sensitivity? → Switch to high sensitivity. <b>P.14</b></li> </ul>
	<ul style="list-style-type: none"> <li>● The monitor indication does not change despite the existence of an odor.</li> <li>● The monitor indication may not change sometimes because the sensitivity of the sensor differs depending on the components of the odor.</li> </ul>
	<ul style="list-style-type: none"> <li>● The monitor responds even though the air in the room is clean.</li> <li>● The monitor may sometimes respond to the wind from an air conditioner in the room or gas that is difficult for a human nose to sense. <b>P.9</b></li> <li>● Is there dust floating in the air? If there is even a small amount of dust floating in the air, the monitor may respond.</li> <li>● Perform “Adjusting the Sensitivity of the PM2.5 Sensor” to see if it helps. <b>P.14</b></li> </ul>
The lamp on the control panel or the clean monitor become darker	<ul style="list-style-type: none"> <li>● During automatic operation “Night”, the lamp of the control panel and the lamp of the clean monitor and i-see Sensor become darker. <b>P.11</b></li> </ul>
The Replace Filter lamp is lit.	<ul style="list-style-type: none"> <li>● It is time to replace the HEPA filter and activated charcoal filter. → Replace the HEPA filter and activated charcoal filter. <b>P.17</b></li> </ul>

If the symptoms persist even after trying the remedies above, stop using the air purifier and disconnect the power plug, and then contact the retail store where you purchased the product.

# Specifications

<b>Model</b>	<b>MA-E100R-E</b>		
<b>Power supply</b>	220-240 V AC, 50 Hz		
<b>Manual operation</b>	High	Middle	Low
<b>Power consumption</b>	82 W	19 W	7 W
<b>Air volume</b>	600 m <sup>3</sup> /h	300 m <sup>3</sup> /h	84 m <sup>3</sup> /h
<b>Weight</b>	13.4 kg		
<b>Dimensions</b>	800 (H) × 320 (W) × 270 (D) mm		
<b>Cord length</b>	1.8 m		

## NOTE



This symbol mark is for EU countries only. This symbol mark is according to the directive 2012/19/EU Article 14 Information for users and Annex IX.

Your MITSUBISHI ELECTRIC product is designed and manufactured with high quality materials and components which can be recycled and reused. This symbol means that electrical and electronic equipment, at their end-of-life, should be disposed of separately from your household waste. Please, dispose of this equipment at your local community waste collection/recycling centre. In the European Union there are separate collection systems for used electrical and electronic product. Please, help us to conserve the environment we live in!

Fill in the following for your future reference.

<b>Place of purchase:</b>	<b>Telephone number:</b>		
<b>Authorised service centre:</b>	<b>Telephone number:</b>		
<b>Date of purchase:</b>	<b>Day</b>	<b>Month</b>	<b>Year</b>

**MITSUBISHI ELECTRIC CORPORATION**