

FLOOR-TYPE AIR CONDITIONERS

INDOOR UNIT

MFZ-KT25VG MFZ-KT35VG MFZ-KT50VG MFZ-KT60VG



OPERATING INSTRUCTIONS

BEDIENUNGSANLEITUNG

NOTICE D'UTILISATION

BEDIENINGSINSTRUCTIES

MANUAL DE INSTRUCCIONES

LIBRETTO D'ISTRUZIONI

ΟΔΗΓΙΕΣ ΛΕΙΤΟΥΡΓΙΑΣ

INSTRUÇÕES DE OPERAÇÃO

BETJENINGSVEJLEDNING

BRUKSANVISNING

РЪКОВОДСТВО ЗА ЕКСПЛОАТАЦИЯ

INSTRUKCJA OBSŁUGI

BRUKSANVISNING

KÄYTTÖOHJEET

NÁVOD K OBSLUZE

NÁVOD NA OBSLUHU

HASZNÁLATI ÚTMUTATÓ

NAVODILA ZA UPORABO

INSTRUCȚIUNI DE UTILIZARE

KASUTUSJUHEND

LIETOŠANAS INSTRUKCIJAS

NAUDOJIMO INSTRUKCIJA

UPUTE ZA UPORABU

UPUTSTVA ZA RUKOVANJE

English

Deutsch

Français

Nederlands

Español

Italiano

Ελληνικά

Português

Dansk

Svenska

Български

Polski

Norsk

Suomi

Čeština

Slovenčina

Magyar

Slovenščina

Română

Eesti

Latviski

Lietuviškai

Hrvatski

Srpski

CONTENTS

■ SAFETY PRECAUTIONS	1
■ DISPOSAL	3
■ NAME OF EACH PART	3
■ PREPARATION BEFORE OPERATION	4
■ SELECTING OPERATION MODES	5
■ FAN SPEED AND AIRFLOW DIRECTION ADJUSTMENT	6
■ I-SAVE OPERATION	7
■ ECONO COOL OPERATION	7
■ TIMER OPERATION (ON/OFF TIMER)	7
■ WEEKLY TIMER OPERATION	8
■ CLEANING	9
■ WHEN YOU THINK THAT TROUBLE HAS OCCURRED	10
■ WHEN THE AIR CONDITIONER IS NOT GOING TO BE USED FOR A LONG TIME	11
■ INSTALLATION PLACE AND ELECTRICAL WORK	11
■ SPECIFICATIONS	12

EN

SAFETY PRECAUTIONS

Meanings of symbols displayed on indoor unit and/or outdoor unit

	WARNING (Risk of fire)	This unit uses a flammable refrigerant. If refrigerant leaks and comes in contact with fire or heating part, it will create harmful gas and there is risk of fire.
		Read the OPERATING INSTRUCTIONS carefully before operation.
		Service personnel are required to carefully read the OPERATING INSTRUCTIONS and INSTALLATION MANUAL before operation.
		Further information is available in the OPERATING INSTRUCTIONS, INSTALLATION MANUAL, and the like.

- Since rotating parts and parts which could cause an electric shock are used in this product, be sure to read these "Safety Precautions" before use.
- Since the cautionary items shown here are important for safety, be sure to observe them.
- After reading this manual, keep it together with the installation manual in a handy place for easy reference.

Marks and their meanings

- WARNING** : Incorrect handling could cause serious hazard, such as death, serious injury, etc. with a high probability.
- CAUTION** : Incorrect handling could cause serious hazard depending on the conditions.



















Meanings of symbols used in this manual



- : Be sure not to do.
- : Be sure to follow the instruction.
- : Never insert your finger or stick, etc.
- : Never step onto the indoor/outdoor unit and do not put anything on them.
- : Danger of electric shock. Be careful.
- : Be sure to disconnect the power supply plug from the power outlet.
- : Be sure to shut off the power.
- : Risk of fire.

WARNING	
	<p>Do not connect the power cord to an intermediate point, use an extension cord, or connect multiple devices to a single AC outlet.</p> <ul style="list-style-type: none"> • This may cause overheating, fire, or electric shock.
	<p>Make sure the power plug is free of dirt and insert it securely into the outlet.</p> <ul style="list-style-type: none"> • A dirty plug may cause fire or electric shock.
	<p>Do not bundle, pull, damage, or modify the power cord, and do not apply heat or place heavy objects on it.</p> <ul style="list-style-type: none"> • This may cause fire or electric shock.
	<p>Do not turn the breaker OFF/ON or disconnect/connect the power plug during operation.</p> <ul style="list-style-type: none"> • This may create sparks, which can cause fire. • After the indoor unit is switched OFF with the remote controller, make sure to turn the breaker OFF or disconnect the power plug.
	<p>Do not expose your body directly to cool air for a prolonged length of time.</p> <ul style="list-style-type: none"> • This could be detrimental to your health.

	<p>The unit should not be installed, relocated, disassembled, altered, or repaired by the user.</p> <ul style="list-style-type: none"> • An improperly handled air conditioner may cause fire, electric shock, injury, or water leakage, etc. Consult your dealer. • If the power supply cord is damaged, it must be replaced by the manufacturer or its service agent in order to avoid a hazard.
	<p>When installing, relocating, or servicing the unit, make sure that no substance other than the specified refrigerant (R32/R410A) enters the refrigerant circuit.</p> <ul style="list-style-type: none"> • Any presence of foreign substance such as air can cause abnormal pressure rise and may result in explosion or injury. • The use of any refrigerant other than that specified for the system will cause mechanical failure, system malfunction, or unit breakdown. In the worst case, this could lead to a serious impediment to securing product safety.
	<p>This appliance is not intended for use by persons (including children) with reduced physical, sensory or mental capabilities, or lack of experience and knowledge, unless they have been given supervision or instruction concerning use of the appliance by a person responsible for their safety.</p> <p>Children should be supervised to ensure that they do not play with the appliance.</p>

SAFETY PRECAUTIONS

 	<p>Do not turn the breaker OFF except the case of burning smell, or when performing maintenance or inspection.</p> <ul style="list-style-type: none"> The refrigerant leakage cannot be detected, and this may cause a fire. <p>Do not install the unit in a place where smoke, gas, or chemicals may fill.</p> <ul style="list-style-type: none"> Do not use any gas equipment for propane, butane or methane, sprays such as bug killer, and paint etc., near by the indoor unit. The refrigerant sensor reacts to it and displays an error. This may cause the unit not to operate. <p>(Procedure in case of refrigerant leakage) If the refrigerant leaks, extinguish a fire such as a heater, and ventilate the room adequately by opening the window.</p> <ul style="list-style-type: none"> Then contact your dealer. The indoor unit spreads the refrigerant by FAN mode to prevent a fire. Do not turn the breaker OFF during this situation.
 	<p>Do not insert your finger, a stick, or other objects into the air inlet or outlet.</p> <ul style="list-style-type: none"> This may cause injury, since the fan inside rotates at high speeds during operation.
 	<p>In case of an abnormal condition (such as a burning smell), stop the air conditioner and disconnect the power plug or turn the breaker OFF.</p> <ul style="list-style-type: none"> A continued operation in the abnormal state may cause a malfunction, fire, or electric shock. In this case, consult your dealer.
 	<p>When the air conditioner does not cool or heat, there is a possibility of refrigerant leakage. If any refrigerant leakage is found, ventilate the room well and consult your dealer immediately. Do not turn the breaker OFF. If a repair involves recharging the unit with refrigerant, ask the service technician for details.</p> <ul style="list-style-type: none"> The refrigerant used in the air conditioner is not harmful. Normally, it does not leak. However, if refrigerant leaks and comes in contact with fire or heating part of such a fan heater, kerosene heater, or cooking stove, it will create harmful gas and there is risk of fire. <p>The user should never attempt to wash the inside of the indoor unit. Should the inside of the unit require cleaning, contact your dealer.</p> <ul style="list-style-type: none"> Unsuitable detergent may cause damage to plastic material inside the unit, which may result in water leakage. Should detergent come in contact with electrical parts or the motor, it will result in a malfunction, smoke, or fire. The appliance shall be stored in a room without continuously operating ignition sources (for example: open flames, an operating gas appliance or an operating electric heater). Be aware that refrigerants may not contain an odour. Do not use means to accelerate the defrosting process or to clean the appliance, other than those recommended by the manufacturer. Do not pierce or burn. <p>This unit should be installed in rooms which exceed the floor space specified in outdoor unit installation manual.</p> <ul style="list-style-type: none"> Refer to outdoor unit installation manual.
	<p>This appliance is intended to be used by expert or trained users in shops, in light industry and on farms, or for commercial use by laypersons.</p>
 CAUTION	
	<p>Do not touch the air inlet or the aluminum fins of the indoor/outdoor unit.</p> <ul style="list-style-type: none"> This may cause injury.
	<p>Do not use insecticides or flammable sprays on the unit.</p> <ul style="list-style-type: none"> This may cause a fire or deformation of the unit.
	<p>Do not expose pets or houseplants to direct airflow.</p> <ul style="list-style-type: none"> This may cause injury to the pets or plants.
	<p>Do not place other electric appliances or furniture under the indoor/outdoor unit.</p> <ul style="list-style-type: none"> Water may drip down from the unit, which may cause damage or malfunction.
	<p>Do not leave the unit on a damaged installation stand.</p> <ul style="list-style-type: none"> The unit may fall and cause injury.
	<p>Do not step on an unstable bench to operate or clean the unit.</p> <ul style="list-style-type: none"> This may cause injury if you fall down.
	<p>Do not pull the power cord.</p> <ul style="list-style-type: none"> This may cause a portion of the core wire to break, which may cause overheating or fire.
	<p>Do not charge or disassemble the batteries, and do not throw them into a fire.</p> <ul style="list-style-type: none"> This may cause the batteries to leak, or cause a fire or explosion.



	<p>Do not operate the unit for more than 4 hours at high humidity (80% RH or more) and/or with windows or outside door left open.</p> <ul style="list-style-type: none"> This may cause the water condensation in the air conditioner, which may drip down, wetting or damaging the furniture. The water condensation in the air conditioner may contribute to growth of fungi, such as mold. <p>Do not use the unit for special purposes, such as storing food, raising animals, growing plants, or preserving precision devices or art objects.</p> <ul style="list-style-type: none"> This may cause deterioration of quality, or harm to animals and plants. <p>Do not expose combustion appliances to direct airflow.</p> <ul style="list-style-type: none"> This may cause incomplete combustion. <p>Never put batteries in your mouth for any reason to avoid accidental ingestion.</p> <ul style="list-style-type: none"> Battery ingestion may cause choking and/or poisoning.
	<p>Before cleaning the unit, switch it OFF and disconnect the power plug or turn the breaker OFF.</p> <ul style="list-style-type: none"> This may cause injury, since the fan inside rotates at high speeds during operation. <p>Replace all batteries of the remote controller with new ones of the same type.</p> <ul style="list-style-type: none"> Using an old battery together with a new one may cause overheating, leakage, or explosion. <p>If the battery fluid comes in contact with your skin or clothes, wash them thoroughly with clean water.</p> <ul style="list-style-type: none"> If the battery fluid comes in contact with your eyes, wash them thoroughly with clean water and immediately seek medical attention. <p>Ensure that the area is well-ventilated when the unit is operated together with a combustion appliance.</p> <ul style="list-style-type: none"> Inadequate ventilation may cause oxygen starvation. <p>Turn the breaker OFF when you hear thunder and there is a possibility of a lightning strike.</p> <ul style="list-style-type: none"> The unit may be damaged if lightning strikes. <p>After the air conditioner is used for several seasons, perform inspection and maintenance in addition to normal cleaning.</p> <ul style="list-style-type: none"> Dirt or dust in the unit may create an unpleasant odor, contribute to growth of fungi, such as mold, or clog the drain passage, and cause water to leak from the indoor unit. Consult your dealer for inspection and maintenance, which require specialized knowledge and skills. <p>Do not operate switches with wet hands.</p> <ul style="list-style-type: none"> This may cause electric shock. <p>Do not clean the air conditioner with water or place an object that contains water, such as a flower vase, on it.</p> <ul style="list-style-type: none"> This may cause fire or electric shock. <p>Do not step on or place any object on the outdoor unit.</p> <ul style="list-style-type: none"> This may cause injury if you or the object falls down.

! IMPORTANT



Dirty filters cause condensation in the air conditioner which will contribute to the growth of fungi such as mold. It is therefore recommended to clean air filters every 2 weeks.

SAFETY PRECAUTIONS

For installation

 WARNING	
	<p>Consult your dealer for installing the air conditioner.</p> <ul style="list-style-type: none"> It should not be installed by the user since installation requires specialized knowledge and skills. An improperly installed air conditioner may cause water leakage, fire, or electric shock.
	<p>Provide a dedicated power supply for the air conditioner.</p> <ul style="list-style-type: none"> A non-dedicated power supply may cause overheating or fire.
	<p>Do not install the unit where flammable gas could leak.</p> <ul style="list-style-type: none"> If gas leaks and accumulates around the outdoor unit, it may cause an explosion.

	<p>Earth the unit correctly.</p> <ul style="list-style-type: none"> Do not connect the earth wire to a gas pipe, water pipe, lightning rod, or a telephone earth wire. Improper earthing may cause electric shock.
---	--

 CAUTION	
	<p>Install an earth leakage breaker depending on the installation location of the air conditioner (such as highly humid areas).</p> <ul style="list-style-type: none"> If an earth leakage breaker is not installed, it may cause electric shock.
	<p>Ensure that the drain water is properly drained.</p> <ul style="list-style-type: none"> If the drain passage is improper, water may drip down from the indoor/outdoor unit, wetting and damaging the furniture.

<p>In case of an abnormal condition</p> <p>Immediately stop operating the air conditioner and consult your dealer.</p>	
---	--

EN

DISPOSAL



To dispose of this product, consult your dealer.

Note:

This symbol mark is for EU countries only. This symbol mark is according to the directive 2012/19/EU Article 14 Information for users and Annex IX, and/or to the directive 2006/66/EC Article 20 Information for end-users and Annex II.

Fig. 1

Your MITSUBISHI ELECTRIC product is designed and manufactured with high quality materials and components which can be recycled and/or reused. This symbol means that electrical and electronic equipment, batteries and accumulators, at their end-of-life, should be disposed of separately from your household waste.

If a chemical symbol is printed beneath the symbol (Fig. 1), this chemical symbol means that the battery or accumulator contains a heavy metal at a certain concentration. This will be indicated as follows:

Hg: mercury (0.0005%), Cd: cadmium (0.002%), Pb: lead (0.004%)

In the European Union there are separate collection systems for used electrical and electronic products, batteries and accumulators.

Please, dispose of this equipment, batteries and accumulators correctly at your local community waste collection/recycling centre.

Please, help us to conserve the environment we live in!

NAME OF EACH PART

Indoor unit

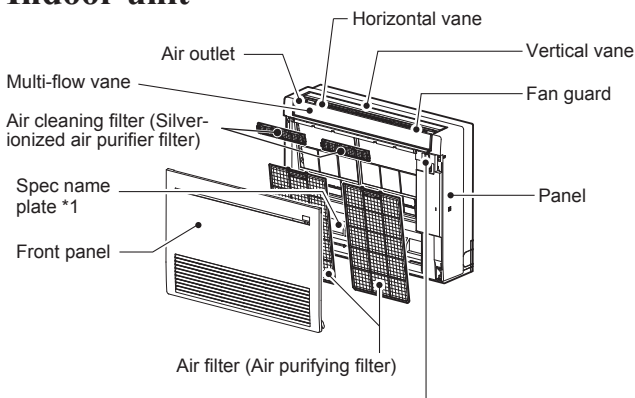

Outdoor unit

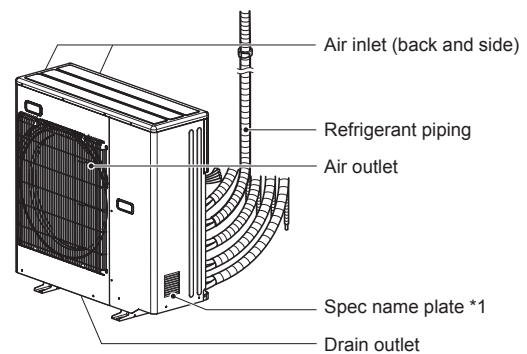

Outdoor units may be different in appearance.

*1 The manufacturing year and month is indicated on the spec name plate.

Display and operation section

(When the front panel is opened)



Emergency operation switch

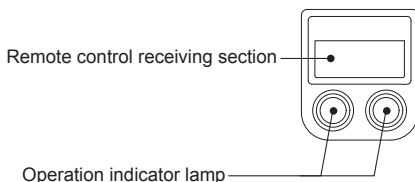

NAME OF EACH PART

Remote controller

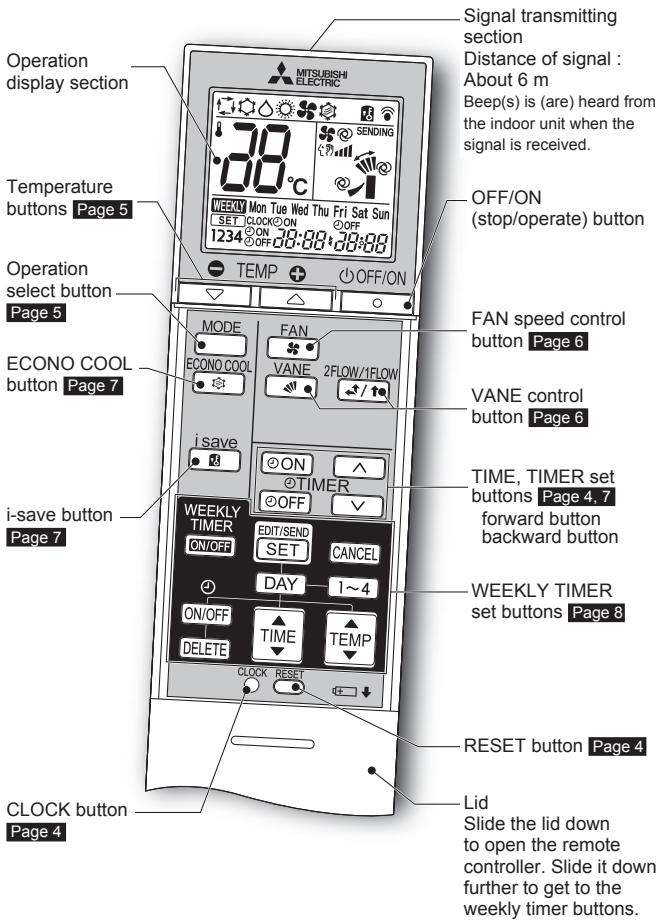

Remote controller holder

- Install the remote controller holder in a place where the signal can be received by the indoor unit.

Only use the remote controller provided with the unit.
Do not use other remote controllers. If two or more indoor units are installed in proximity to one another, an indoor unit that is not intended to be operated may respond to the remote controller.

PREPARATION BEFORE OPERATION

Before operation: Insert the power supply plug into the power outlet and/or turn the breaker on.

Installing the remote controller batteries

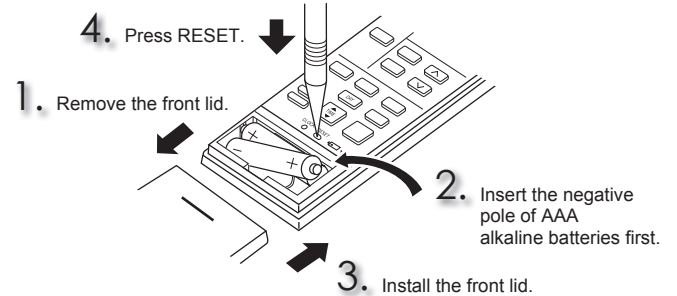

Note:

- Make sure the polarity of the batteries is correct.
- Do not use manganese batteries and leaking batteries. The remote controller could malfunction.
- Do not use rechargeable batteries.
- The battery replacement indicator lights up when the battery is running low. In about 7 days after the indicator starts lights up, the remote controller stops working.
- Replace all batteries with new ones of the same type.
- Batteries can be used for approximately 1 year. However, batteries with expired shelf lives last shorter.
- Press RESET gently using a thin instrument.
If the RESET button is not pressed, the remote controller may not operate correctly.

Setting current time

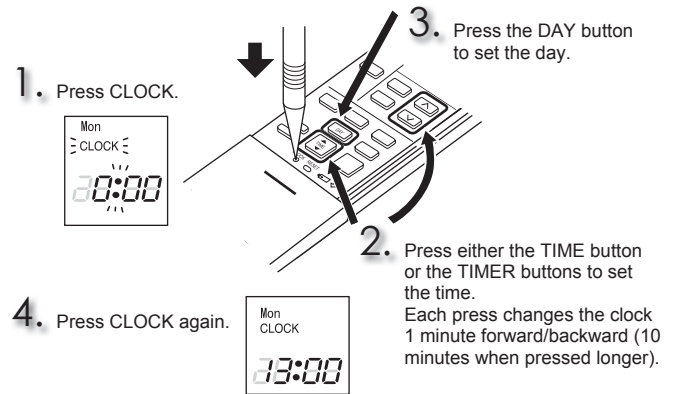

Note:

- Press CLOCK gently using a thin instrument.

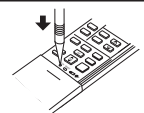

EN

SELECTING OPERATION MODES

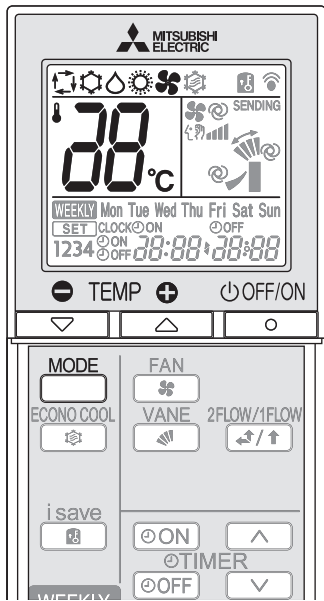

1 Press to start the operation.

2 Press to select operation mode. Each press changes mode in the following order:

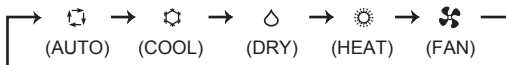

3 Press or to set the temperature. Each press raises or lowers the temperature by 1°C.

Press to stop the operation.

Note:

Operation indicator lamp

The operation indicator lamp shows the operation state of the unit.

Indication	Operation state	Room temperature
	The unit is operating to reach the set temperature	About 2°C or more away from set temperature
	The room temperature is approaching the set temperature	About 1 to 2°C from set temperature
	Standby mode (Refer to multi system operation)	—

Lit Blinking Not lit

Multi system operation

Two or more indoor units can be operated by one outdoor unit. When several indoor units are operated simultaneously, cooling and heating operations cannot be done at the same time. When COOL is selected with one unit and HEAT with another or vice versa, the unit operated later becomes standby mode.

Water may condense when HEAT is operated with other units within 3 hours after COOL/DRY operation is stopped.
To prevent water condensation, perform HEAT with temperature set to 16°C for about 30 minutes after COOL/DRY operation.

AUTO mode (Auto change over)

The unit selects the operation mode according to the difference between the room temperature and the set temperature. During AUTO mode, the unit changes mode (COOL↔HEAT) when the room temperature is about 2°C away from the set temperature for more than 15 minutes.

Note:

During multi system operation, the unit may not be able to switch operation mode between COOL and HEAT. In this case, the indoor unit becomes standby mode (Refer to table of Operation indicator lamp).

COOL mode

Enjoy cool air at your desired temperature.

Note:

Do not operate COOL mode at very low outside temperatures (less than -10°C). Water condensed in the unit may drip and wet or damage furniture, etc.

DRY mode

Dehumidify your room. The room may be cooled slightly. Temperature cannot be set during DRY mode.

HEAT mode

Enjoy warm air at your desired temperature.

FAN mode

Circulate the air in your room. Temperature cannot be set during FAN mode.

Note:

After COOL/DRY mode operation, it is recommended to operate in the FAN mode to dry inside the indoor unit.

Emergency operation

When the remote controller cannot be used...

Emergency operation can be activated by pressing the emergency operation switch (E.O SW) on the indoor unit.

Each time the E.O SW is pressed, the operation changes in the following order:

Operation indicator lamp

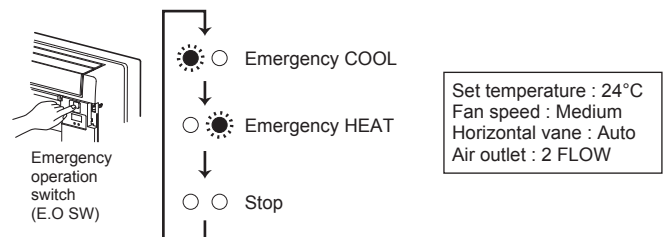

Note:

- The first 30 minutes of operation is test run. Temperature control does not work, and fan speed is set to High. The air outlet selection is set to 2 FLOW. **Page 6**
- In the emergency heating operation, the fan speed gradually rises to blow out warm air.

Auto restart function

If a power failure occurs or the main power is turned off during operation, "Auto restart function" automatically starts operation in the same mode as the one set with the remote controller just before the shutoff of the main power. When timer is set, timer setting is cancelled and the unit starts operation when power is resumed.

If you do not want to use this function, please consult the service representative because the setting of the unit needs to be changed.

FAN SPEED AND AIRFLOW DIRECTION ADJUSTMENT

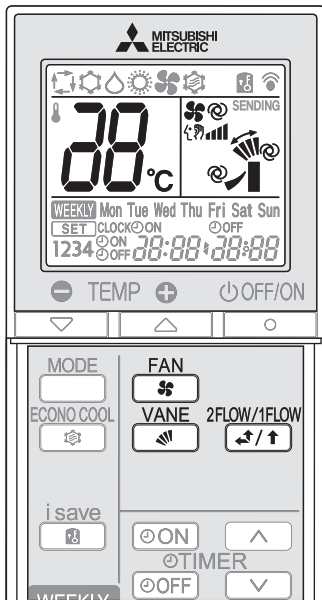

Press **FAN** to select fan speed. Each press changes fan speed in the following order:

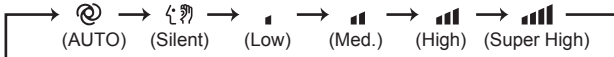

- Two short beeps are heard from the indoor unit when set to AUTO.
- Use higher fan speed to cool/heat the room quicker. It is recommended to lower the fan speed once the room is cool/warm.
- Use lower fan speed for quiet operation.

Note:

Multi system operation

When several indoor units are operated simultaneously by one outdoor unit for heating operation, the temperature of the airflow may be low. In this case, it is recommended to set the fan speed to AUTO.

Press **VANE** to select vertical airflow direction. Each press will change airflow direction in the following order:

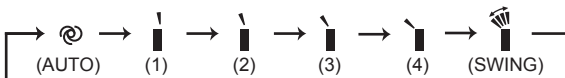

- Two short beeps will be heard from the indoor unit when set to AUTO.
- Moving the horizontal vane/multi-flow vane manually can cause trouble.
- The horizontal vane/multi-flow vane automatically moves in certain intervals to determine its position, and then it returns to the set position.
- When the air outlet is switched between 1 FLOW and 2 FLOW, the horizontal vanes may move and change their positions.

Air outlet selection

Press **2FLOW/1FLOW** to select the air outlet(s).
When 2 FLOW is selected, air blows from the top and the front of the unit. When 1 FLOW is selected, air blows only from the top of the unit.

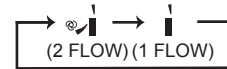

The multi-flow vane is automatically set to the appropriate position. Even if 2 FLOW is selected, air will blow only from the top of the unit in the following conditions:

- During COOL/DRY: The room temperature is close to set temperature. The air conditioner has operated for 0.5 to 1 hour.
- During HEAT: The air flow temperature is low. (During defrosting operation, start of operation, etc.)

Note:

Movement at the start of the 2 FLOW operation

- COOL/DRY, HEAT: It takes 0.5 to 1 minute to start the 2 FLOW operation.
- HEAT: When cold air blows out from the air outlet, the multi-flow vane may stop moving for up to 10 minutes to make and blow out warm air.

Airflow direction

- (AUTO).....The vane will be set to the most efficient airflow direction.
COOL/DRY/FAN (2 FLOW) : position (2)
COOL/DRY/FAN (1 FLOW) : position (1)
HEAT (2 FLOW) : position (2)
HEAT (1 FLOW) : position (3)

- (Manual).....For efficient air conditioning, select upper position for COOL/DRY, and lower position for HEAT. During COOL/DRY, when the vane is set to position (3) or (4), the vane automatically moves to position (1) after 0.5 to 1 hour to prevent water dripping.

- (Swing).....The horizontal vane will move up and down intermittently.

To change the horizontal airflow direction.

Move the vertical vane manually before starting operation.

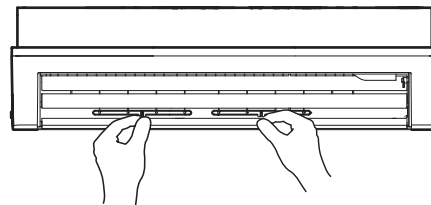

I-SAVE OPERATION

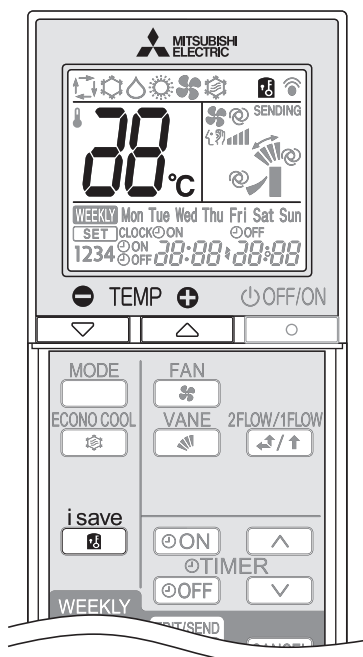

1 Press **i save** during COOL, or HEAT mode to select i-save mode.

2 Set the temperature, fan speed, airflow direction, and 2 FLOW/1 FLOW.

- The same setting is selected from the next time by simply pressing **i save**.
- Two settings can be saved. (One for COOL, one for HEAT)
- Select the appropriate temperature, fan speed, airflow direction, and 2 FLOW/1 FLOW according to your room.
- Normally, the minimum temperature setting in HEAT mode is 16°C. However, during i-save operation only, the minimum temperature setting is 10°C.

Press **i save** again to cancel i-save operation.

- i-save operation also is cancelled when the MODE button is pressed.

i-save operation

- A simplified set back function enables to recall the preferred (preset) setting with a single push of the **i save** button. Press the button again and you can go back to the previous setting in an instance.
- i-save operation cannot be set on the weekly timer.

Example of use:

1. Low energy mode
Set the temperature 2°C to 3°C warmer in COOL and cooler in HEAT mode. This setting is suitable for unoccupied room, and while you are sleeping.
2. Saving frequently used settings
Save your preferred setting for COOL and HEAT. This enables you to select your preferred setting with a single push of the button.

ECONO COOL OPERATION

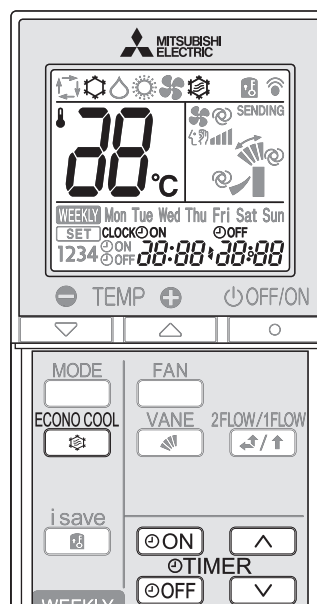

Press **ECONO COOL** during COOL mode **page 5** to start ECONO COOL operation.

The unit performs swing operation vertically in various cycles according to the temperature airflow.

Press **ECONO COOL** again to cancel ECONO COOL operation.

- ECONO COOL operation is also cancelled when the VANE button is pressed.

What is "ECONO COOL"?

Swing airflow (change of air flow) makes you feel cooler than stationary airflow. The set temperature and the airflow direction are automatically changed by the microprocessor. It is possible to perform cooling operation with keeping comfort. As a result energy can be saved.

TIMER OPERATION (ON/OFF TIMER)

1 Press **ON** or **OFF** during operation to set the timer.

ON (ON timer) : The unit turns ON at the set time.

OFF (OFF timer) : The unit turns OFF at the set time.

* **ON** or **OFF** blinks.

* **Make sure that the current time and day are set correctly. Page 4**

2 Press **▲** (forward) and **▼** (backward) to set the time of timer.

Each press changes the set time 10 minutes forward/backward.

- Set the timer while **ON** or **OFF** is blinking.

3 Press **ON** or **OFF** again to cancel timer.

Note:

- ON and OFF timers can be set together. **↑** mark indicates the order of timer operations.
- If power failure occurs while ON/OFF timer is set, see **page 5** "Auto restart function".

WEEKLY TIMER OPERATION

- A maximum of 4 ON or OFF timers can be set for individual days of the week.
- A maximum of 28 ON or OFF timers can be set for a week.

E.g. : Runs at 24°C from waking up to leaving home, and runs at 27°C from getting home to going to bed on weekdays.
Runs at 27°C from waking up late to going to bed early on weekends.

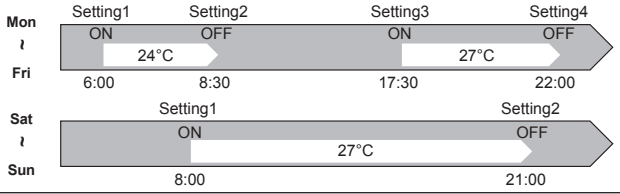

Note:

The simple ON/OFF timer setting is available while the weekly timer is on. In this case, the ON/OFF timer has priority over the weekly timer; the weekly timer operation will start again after the simple ON/OFF timer is complete.

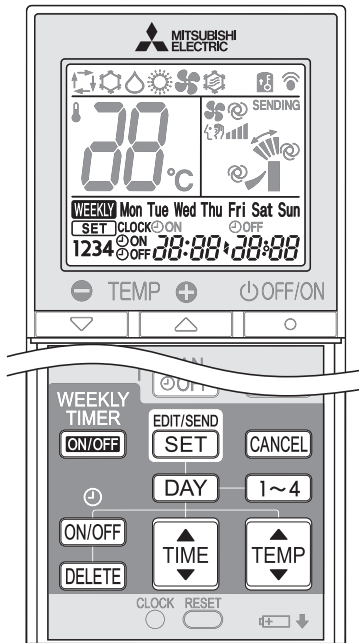

Setting the weekly timer

* Make sure that the current time and day are set correctly.

- 1 Press **EDIT/SEND** **SET** to enter the weekly timer setting mode.

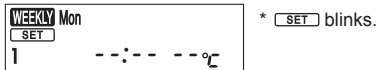

- 2 Press **DAY** and **1~4** to select setting day and number.



Pressing **DAY** selects the day of the week to be set.

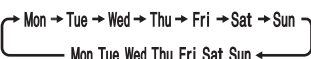

* All days can be selected.

Pressing **1~4** selects the setting number.

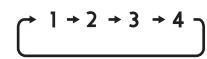

- 3 Press **ON/OFF**, **TIME**, and **TEMP** to set ON/OFF, time, and temperature.

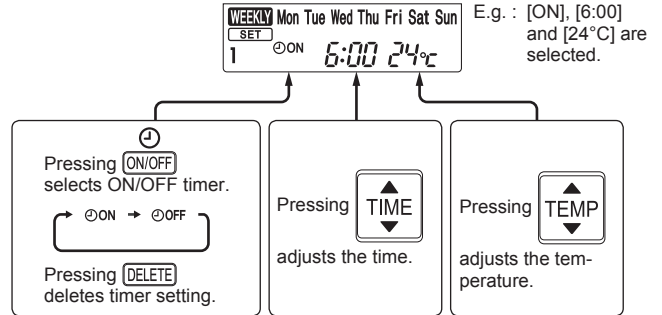

* Hold down the button to change the time quickly.

* The temperature can be set between 16°C and 31°C at weekly timer.

Press **DAY** and **1~4** to continue setting the timer for other days and/or numbers.

- 4 Press **EDIT/SEND** **SET** to complete and transmit the weekly timer setting.



Note:

- Press **EDIT/SEND** **SET** to transmit the setting information of weekly timer to the indoor unit. Point the remote controller toward the indoor unit for 3 seconds.
- When setting the timer for more than one day of the week or one number, **EDIT/SEND** **SET** does not have to be pressed per each setting. Press **EDIT/SEND** **SET** once after all the settings are complete. All the weekly timer settings will be saved.
- Press **EDIT/SEND** **SET** to enter the weekly timer setting mode, and press and hold **DELETE** for 5 seconds to erase all weekly timer settings. Point the remote controller toward the indoor unit.

- 5 Press **WEEKLY TIMER ON/OFF** to turn the weekly timer ON. (**WEEKLY** lights.)

* When the weekly timer is ON, the day of the week whose timer setting is complete, will light.

- Press **WEEKLY TIMER ON/OFF** again to turn the weekly timer OFF. (**WEEKLY** goes out.)

Note:

The saved settings will not be cleared when the weekly timer is turned OFF.

Checking weekly timer setting

- 1 Press **EDIT/SEND** **SET** to enter the weekly timer setting mode.

* **SET** blinks.

- 2 Press **DAY** or **1~4** to view the setting of the particular day or number.

Press **CANCEL** to exit the weekly timer setting.

CLEANING

Instructions:

- Switch off the power supply or turn off the breaker before cleaning.
- Be careful not to touch the metal parts with your hands.
- Do not use benzine, thinner, polishing powder, or insecticide.
- Use only diluted neutral detergents.
- Do not expose parts to direct sunlight, heat, or flames to dry.
- Do not use water hotter than 50°C.
- Do not use a scrubbing brush, a hard sponge, or the like.
- Do not soak or rinse the horizontal vane.

EN

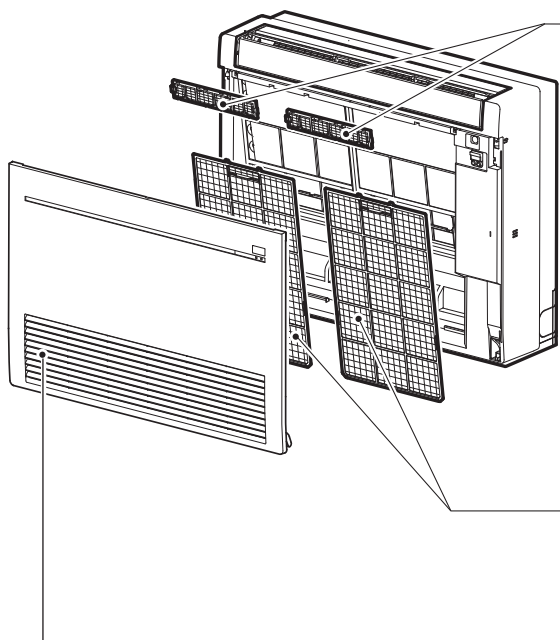

Front panel

1. Push down the tab on the both sides of the unit to open the front panel.
2. Pull the front panel toward you to remove it.
3. Open the front panel completely and then remove it.
 - Wipe with a soft dry cloth or wash it with water.
 - Do not soak it in water for more than two hours.
 - Dry it well in shade before installing it.
4. Install the front panel by following the removal procedure in reverse.

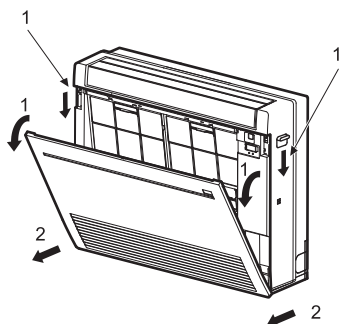

Air cleaning filter (Silver-ionized air purifier filter)

Back side of air filter

Clean every 3 months:

- Remove dirt by a vacuum cleaner.

When dirt cannot be removed by vacuum cleaning:

- Soak the filter and its frame in lukewarm water before rinsing it. (Diluted mild detergents can be used when dirt cannot be removed.)
- After washing, dry it well in shade.

Every year:

- Replace it with a new air cleaning filter for best performance.
- Parts Number **MAC-2370FT-E**

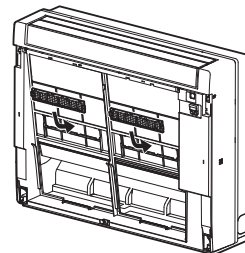

Air filter (Air purifying filter)

Clean every 2 weeks

- Remove dirt by a vacuum cleaner, or rinse with water.
- After washing with water, dry it well in shade.

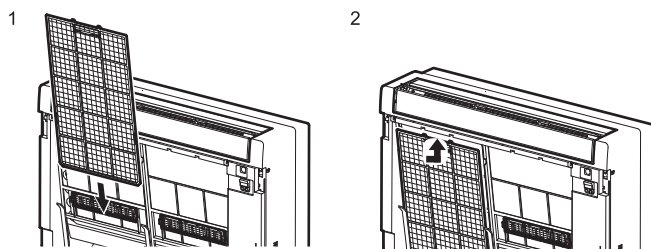

! Important

- Clean the filters regularly for best performance and to reduce power consumption.
- Dirty filters cause condensation in the air conditioner which will contribute to the growth of fungi such as mold. It is therefore recommended to clean air filters every 2 weeks.

This information is based on REGULATION (EU) No 528/2012

MODEL NAME	Treated Article (Parts name)	Active Substances (CAS No.)	Property	Instruction for Use (Safe handling information)
MFZ-KT25/35/50/60VG	FILTER	Silver sodium hydrogen zirconium phosphate (265647-11-8)	Antibacterial Antimold	<ul style="list-style-type: none"> • Use this product in line with the instruction manual indications and for the intended purpose only. • Do not put into mouth. Keep away from children.
		Silver zinc zeolite (130328-20-0)	Antibacterial	<ul style="list-style-type: none"> • Use this product in line with the instruction manual indications and for the intended purpose only. • Do not put into mouth. Keep away from children.
MAC-2370FT-E	FILTER	Silver zinc zeolite (130328-20-0)	Antibacterial	<ul style="list-style-type: none"> • Use this product in line with the instruction manual indications and for the intended purpose only. • Do not put into mouth. Keep away from children.

WHEN YOU THINK THAT TROUBLE HAS OCCURRED

Even if these items are checked, when the unit does not recover from the trouble, stop using the air conditioner and consult your dealer.

Symptom	Explanation & Check points
Indoor Unit	
The unit cannot be operated.	<ul style="list-style-type: none"> Is the breaker turned on? Is the power supply plug connected? Is the ON timer set?
The unit cannot be operated for about 3 minutes when restarted.	<ul style="list-style-type: none"> This protects the unit according to instructions from the microprocessor. Please wait.
Mist is discharged from the air outlet of the indoor unit.	<ul style="list-style-type: none"> The cool air from the unit rapidly cools moisture in the air inside the room, and it turns into mist.
The swing operation of the HORIZONTAL VANE is suspended for a while, then restarted.	<ul style="list-style-type: none"> This is for the swing operation of the HORIZONTAL VANE to be performed normally.
The air flow direction changes during operation. The direction of the horizontal vane/multi-flow vane cannot be adjusted with the remote controller.	<ul style="list-style-type: none"> In the heating operation, if the air flow temperature is too low or when defrosting is being done, the horizontal vane is automatically set to vertical position. The multi-flow vane is set to the closed position. When the air conditioner is operated in COOL or DRY mode, if the operation continues with air blowing horizontally for 1 hour, the direction of the air flow is automatically set to position (1) to prevent condensed water from dropping. The multi-flow vane is set to the closed position. The horizontal vane and the multi-flow vane automatically moves in certain intervals to determine its position, and then it returns to the set position.
The operation is stopped for about 10 minutes in the heating operation.	<ul style="list-style-type: none"> Defrosting of the outdoor unit is being done. Since this is completed in max.10 minutes, please wait. (When the outside temperature is too low and humidity is too high, frost is formed.)
The unit starts operation by itself when the main power is turned on, though it isn't operated with the remote controller.	<ul style="list-style-type: none"> These models are equipped with an auto restart function. When the main power is turned off without stopping the unit with the remote controller and is turned on again, the unit starts operation automatically in the same mode as the one set with the remote controller just before the shutdown of the main power. Refer to "Auto restart function". Page 5
The multi-flow vane opens and closes automatically.	<ul style="list-style-type: none"> The multi-flow vane is automatically controlled by a microcomputer according to the air flow temperature and operation time of the air conditioner.
The indoor unit which is not operating becomes warm and a sound, similar to water flowing, is heard from the unit.	<ul style="list-style-type: none"> A small amount of refrigerant continues to flow into the indoor unit even though it is not operating.
The indoor unit discolors over time.	<ul style="list-style-type: none"> Although plastic turns yellow due to the influence of some factors such as ultraviolet light and temperature, this has no effect on the product functions.
Outdoor Unit (Multi system)	
When heating operation is selected, operation does not start right away.	<ul style="list-style-type: none"> When operation is started during defrosting of outdoor unit is done, it takes a few minutes (max. 10 minutes) to blow out warm air.
The fan of the outdoor unit does not rotate even though the compressor is running. Even if the fan starts to rotate, it stops soon.	<ul style="list-style-type: none"> When the outside temperature is low during cooling operation, the fan operates intermittently to maintain sufficient cooling capacity.
Water leaks from the outdoor unit.	<ul style="list-style-type: none"> During COOL and DRY operations, pipe or pipe connecting sections are cooled and this causes water to condense. In the heating operation, water condensed on the heat exchanger drips down. In the heating operation, the defrosting operation makes water frozen on the outdoor unit melt and drip down.
White smoke is discharged from the outdoor unit.	<ul style="list-style-type: none"> In the heating operation, vapor generated by the defrosting operation looks like white smoke.
Remote controller	
The display on the remote controller does not appear or it is dim. The indoor unit does not respond to the remote control signal.	<ul style="list-style-type: none"> Are the batteries exhausted? Page 4 Is the polarity (+, -) of the batteries correct? Page 4 Are any buttons on the remote controller of other electric appliances being pressed?

Symptom	Explanation & Check points
Does not cool or heat	
The room cannot be cooled or heated sufficiently.	<ul style="list-style-type: none"> Is the temperature setting appropriate? Page 5 Is the fan setting appropriate? Please change fan speed to High or Super High. Page 6 Is the air outlet selection is set to 1 FLOW? Set it to 2 FLOW. Page 6 Is the filter clean? Page 9 Is the fan or heat exchanger of the indoor unit clean? Are there any obstacles blocking the air inlet or outlet of the indoor or outdoor unit? Is a window or door open? It may take a certain time to reach the setting temperature or may not reach that depending on the size of the room, the ambient temperature, and the like.
The room cannot be cooled sufficiently.	<ul style="list-style-type: none"> When a ventilation fan or a gas cooker is used in a room, the cooling load increases, resulting in an insufficient cooling effect. When the outside temperature is high, the cooling effect may not be sufficient.
The room cannot be heated sufficiently.	<ul style="list-style-type: none"> When the outside temperature is low, the heating effect may not be sufficient.
Air does not blow out soon in the heating operation.	<ul style="list-style-type: none"> Please wait as the unit is preparing to blow out warm air.
Airflow	
The air from the indoor unit smells strange.	<ul style="list-style-type: none"> Is the filter clean? Page 9 Is the fan or heat exchanger of the indoor unit clean? The unit may suck in an odor adhering to the wall, carpet, furniture, cloth, etc. and blow it out with the air.
Sound	
Cracking sound is heard.	<ul style="list-style-type: none"> This sound is generated by the expansion/contraction of the panel, etc. due to change in temperature.
The sound as burbling is heard.	<ul style="list-style-type: none"> This sound is heard when the outside air is absorbed from the drain hose by turning on the range hood or the ventilation fan, making water flowing in the drain hose to spout out. This sound is also heard when the outside air blows into the drain hose in case the outside wind is strong.
Mechanical sound is heard from the indoor unit.	<ul style="list-style-type: none"> This is the switching sound in turning on/off the fan or the compressor.
The sound of water flowing is heard.	<ul style="list-style-type: none"> This is the sound of refrigerant or condensed water flowing in the unit.
Hissing sound is sometimes heard.	<ul style="list-style-type: none"> This is the sound when the flow of refrigerant inside the unit is switched.
The sound of motor and swirling sound is heard from the indoor unit.	<ul style="list-style-type: none"> This is the sound of water condensed during COOL/DRY operation being drained from the indoor unit. Sound of water draining may also be heard from indoor units which are not operating. (The sound will stop automatically. Please wait.)
Timer	
Weekly timer does not operate according to settings.	<ul style="list-style-type: none"> Is the ON/OFF timer set? Page 7 Transmit the setting information of the weekly timer to the indoor unit again. When the information is successfully received, a long beep will sound from the indoor unit. If information fails to be received, 3 short beeps will be heard. Ensure information is successfully received. Page 8 When a power failure occurs and the main power turns off, the indoor unit built-in clock will be incorrect. As a result, the weekly timer may not work normally. Be sure to place the remote controller where the signal can be received by the indoor unit. Page 4
The unit starts/stops the operation by itself.	<ul style="list-style-type: none"> Is the weekly timer set? Page 8

EN

WHEN YOU THINK THAT TROUBLE HAS OCCURRED

In the following cases, stop using the air conditioner and consult your dealer.

- When water leaks or drips from the indoor unit.
- When the left operation indicator lamp blinks.
- When the breaker trips frequently.
- The remote control signal is not received in a room where an electronic ON/OFF type fluorescent lamp (inverter-type fluorescent lamp, etc.) is used.
- Operation of the air conditioner interferes with radio or TV reception. An amplifier may be required for the affected device.
- When an abnormal sound is heard.
- When any refrigerant leakage is found.

WHEN THE AIR CONDITIONER IS NOT GOING TO BE USED FOR A LONG TIME

EN

- 1 Set to the highest temperature in manual COOL mode, and operate for 3 to 4 hours. **Page 5**
 - This dries the inside of the unit.
 - Moisture in the air conditioner contributes to favorable conditions for growth of fungi, such as mold.

- 2 Press  to stop the operation.

- 3 Do not turn the breaker OFF except the case of burning smell, or when performing maintenance or inspection. The refrigerant leakage cannot be detected, and this may cause a fire.

- 4 Remove all batteries from the remote controller.

When using the air conditioner again:

- 1 Clean the air filter. **Page 9**
- 2 Check that the air inlet and outlet of the indoor and outdoor units are not blocked.
- 3 Check that the earth is connected correctly.
- 4 Refer to the "PREPARATION BEFORE OPERATION", and follow the instructions. **Page 4**

INSTALLATION PLACE AND ELECTRICAL WORK

Installation place

Avoid installing the air conditioner in the following places.

- Where there is much machine oil.
- Salty places such as the seaside.
- Where sulfide gas is generated such as hot spring, sewage, waste water.
- Where oil is splashed or where the area is filled with oily smoke (such as cooking areas and factories, in which the properties of plastic could be changed and damaged).
- Where there is high-frequency or wireless equipment.
- Where the air from the outdoor unit air outlet is blocked.
- Where the operation sound or air from the outdoor unit bothers the house next door.
- Do not install the indoor unit at a place higher than 150 mm.
- Do not operate the air conditioner during interior construction and finishing work, or while waxing the floor. Before operating the air conditioner, ventilate the room well after such work is performed. Otherwise, it may cause volatile elements to adhere inside the air conditioner, resulting in water leakage or scattering of dew.

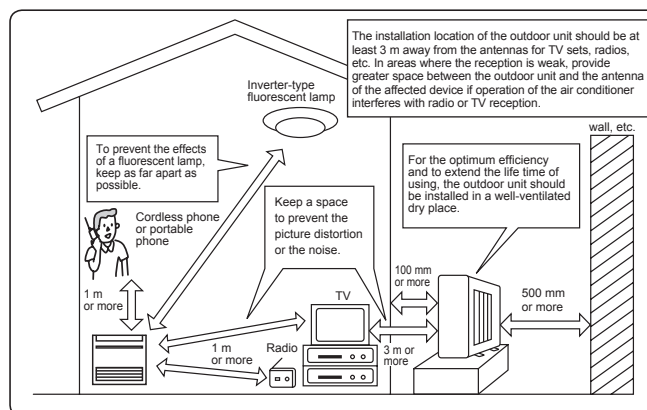

Electrical work

- Provide an exclusive circuit for the power supply of the air conditioner.
- Be sure to observe the breaker capacity.

If you have any questions, consult your dealer.

SPECIFICATIONS

Model	Set name		—		—		—		—	
	Indoor		MFZ-KT25VG		MFZ-KT35VG		MFZ-KT50VG		MFZ-KT60VG	
	Outdoor		—		—		—		—	
Function			Cooling	Heating	Cooling	Heating	Cooling	Heating	Cooling	Heating
Power supply	~N, 230 V, 50 Hz									
Capacity		kW	—	—	—	—	—	—	—	—
Input		kW	0.020	0.024	0.020	0.024	0.037	0.052	0.063	0.059
Weight	Indoor	kg	14.5						15.0	
IP code	Indoor		IP20							
Permissible excessive operating pressure	LP ps	MPa	—							
	HP ps	MPa	4.15							
Noise level (Single)	Indoor (Super High/High/Med./Low/Silent)	dB(A)	41/37/31/24/19	44/37/30/23/19	41/37/31/24/19	44/37/30/23/19	48/42/37/32/28	49/44/40/35/29	53/46/40/36/28	51/47/41/35/29
Air flow volume (Single)	Indoor (Super High/High/Med./Low/Silent)	m ³ /min	8.9/7.8/6.5/4.8/3.9	9.7/7.3/5.6/4.0/3.5	8.9/7.8/6.5/4.8/3.9	9.7/7.3/5.6/4.0/3.5	12.3/10.4/8.6/6.7/5.6	14.0/11.6/9.4/7.7/6.0	15.0/12.3/9.6/8.0/5.6	14.6/12.5/9.7/7.7/6.0
Noise level (Multi)	Indoor (Super High/High/Med./Low/Silent)	dB(A)	43/38/33/28/23	44/39/34/28/24	43/38/33/28/23	44/39/34/28/24	48/42/37/32/28	49/44/40/35/29	—	—
Air flow volume (Multi)	Indoor (Super High/High/Med./Low/Silent)	m ³ /min	9.0/7.8/6.5/4.8/4.2	9.7/7.8/6.3/4.9/4.2	9.0/7.8/6.5/4.8/4.2	9.7/7.8/6.3/4.9/4.2	12.3/10.4/8.6/6.7/5.6	14.0/11.6/9.4/7.7/6.0	—	—

Guaranteed operating range

		Indoor	Outdoor
Cooling	Upper limit	32°C DB 23°C WB	*Note 2
	Lower limit	21°C DB 15°C WB	
Heating	Upper limit	27°C DB —	
	Lower limit	20°C DB —	

DB: Dry Bulb
WB: Wet Bulb

Note:

- Rating condition
Cooling — Indoor: 27°C DB, 19°C WB
Outdoor: 35°C DB
Heating — Indoor: 20°C DB
Outdoor: 7°C DB, 6°C WB
- As for specifications, please confirm your dealer and/or refer to the catalogue.

Model	MFZ-KT25VG		MFZ-KT35VG	MFZ-KT50VG
Cooling Capacity	sensible	P _{rated,c} kW	1.98	2.45
	latent	P _{rated,c} kW	0.52	1.05
Heating Capacity		P _{rated,h} kW	2.90	4.00
Total electric power input		P _{elec} kW	0.024	0.024
Sound power level (per speed setting, if applicable)		L _{WA} dB(A)	54/47/43/37/35	54/47/43/37/35
				60/54/49/42/39

(EU)2016/2281

EN

Importer:

Mitsubishi Electric Europe B.V.
Capronilaan 46, 1119 NS, Schiphol Rijk, The Netherlands

French Branch
25, Boulevard des Bouvets, 92741 Nanterre Cedex, France

German Branch
Mitsubishi-Electric-Platz 1, 40882 Ratingen, Germany

Belgian Branch
Autobaan 2, 8210 Loppem, Belgium

Irish Branch
Westgate Business Park, Ballymount, Dublin 24, Ireland

Italian Branch
Centro Direzionale Colleoni, Palazzo Sirio-Ingresso 1 Viale Colleoni 7, 20864 Agrate Brianza (MB), Italy

Norwegian Branch
Gneisveien 2D, 1914 Ytre Enebakk, Norway

Portuguese Branch
Avda. do Forte, 10, 2799-514, Carnaxide, Lisbon, Portugal

Spanish Branch
Carretera de Rubi 76-80 - Apdo. 420 08173 Sant Cugat del Valles (Barcelona), Spain

Scandinavian Branch
Hammarbacken 14, P.O. Box 750 SE-19127, Sollentuna, Sweden

UK Branch
Travellers Lane, Hatfield, Herts., AL10 8XB, England, U.K.

Polish Branch
Krakowska 50, PL-32-083 Balice, Poland

EC DECLARATION OF CONFORMITY
EG-KONFORMITÄTSESKLÄRUNG
DÉCLARATION DE CONFORMITÉ CE
EG-CONFORMITEITSVERKLARING
DECLARACIÓN DE CONFORMIDAD CE
DICHIARAZIONE DI CONFORMITÀ CE
ΔΗΛΩΣΗ ΠΙΣΤΟΤΗΤΑΣ ΕΚ
DECLARAÇÃO DE CONFORMIDADE CE
EU-OVERENSSTEMMELSESERKLÆRING

EG-DEKLARATION OM ÖVERENSSTÄMMELSE
EC UYGUNLUK BEYANI
ΕΣ ΔΕΚΛΑΡΑΪΑ ΖΑ ΣΨΟΤΒΕΤΣΒΙΕ
DEKLARACJA ZGODNOŚCI WE
CE-ERKLÆRING OM SAMSVAR
EY-VAATIMUSTENMUKAISUUSVAKUUTUS
ES PROHLÁŠENÍ O SHODĚ
VYHLÁSENIE O ZHODE ES
EK MEGFELELŐSÉGI NYILATKOZAT

IZJAVA O SKLADNOSTI ES
DECLARAȚIE DE CONFORMITATE CE
EU VASTAVUSDEKLARATSIOON
EK ATBILSTĪBAS DEKLARĀCIJA
EB ATITIKTIES DEKLARĀCIJA
EC IZJAVA O SUKLADNOSTI
EZ IZJAVA O USAGLAŠENOSTI
ДЕКЛАРАЦИЯ СООТВЕТСТВИЯ НОРМАМ ЕС
ДЕКЛАРАЦІЯ ВІДПОВІДНОСТІ НОРМАМ ЄС

MITSUBISHI ELECTRIC CORPORATION, SHIZUOKA WORKS
18-1, OSHIKA 3-CHOME, SURUGA-KU, SHIZUOKA-CITY 422-8528, JAPAN

hereby declares under its sole responsibility that the air conditioners and heat pumps described below for use in residential, commercial and light-industrial environments:
erklärt hiermit auf seine alleinige Verantwortung, dass die Klimaanlage und Wärmepumpen für das häusliche, kommerzielle und leicht-industrielle Umfeld wie unten beschrieben:
déclare par la présente et sous sa propre responsabilité que les climatiseurs et les pompes à chaleur décrits ci-dessous, destinés à un usage dans des environnements résidentiels, commerciaux et d'industrie légère :
verklaart hierbij onder eigen verantwoordelijkheid dat de voor residentiële, commerciële en licht-industriële omgevingen bestemde airconditioners en warmtepompen zoals onderstaand beschreven:
por la presente declara bajo su única responsabilidad que los acondicionadores de aire y bombas de calor descritas a continuación para su uso en entornos residenciales, comerciales y de industria ligera:
conferma con la presente, sotto la sua esclusiva responsabilità, che i condizionatori d'aria e le pompe di calore descritti di seguito e destinati all'utilizzo in ambienti residenziali, commerciali e semi-industriali:
με το παρόν πιστοποιώ με αποκλειστική της ευθύνη ότι οι τα κλιματιστικά και οι αντλίες θέρμανσης που περιγράφονται παρακάτω για χρήση σε οικιακό, επαγγελματικό και ελαφριάς βιομηχανίας περιβάλλοντα:
através da presente declara sob sua única responsabilidade que os aparelhos de ar condicionado e bombas de calor abaixo descritos para uso residencial, comercial e de indústria ligeira:
erklærer hermed under eneansvar, at de herunder beskrevne airconditionanlæg og varmepumper til brug i privat boligbyggeri, erhvervsområder og inden for let industri:
intyggar härmed att luftkonditioneringarna och värmepumparna som beskrivs nedan för användning i bostäder, kommersiella miljöer och lätta industriella miljöer:
ev, ticaret ve hafif sanayi ortamlarında kullanılmaya elverişli üretilen ve aşağıda açıklanan klima ve ısıtma pompalarıyla ilgili aşağıdaki hususları yalnızca kendi sorumluluğunda beyan eder:
декларира на своя собствена отговорност, че климатизиците и термopмпите, описани по-долу, за употреба в жилищни, търговски и леки промишлени условия:
niniejszym oświadczam na swoją wyłączną odpowiedzialność, że klimatyzatory i pompy ciepła opisane poniżej, są przeznaczone do zastosowań w środowisku mieszkalnym, handlowym i lekkim przemysłowym:
erklærer et fullstendig ansvar for undernevnte klimaanlegg og varmepumper ved bruk i boliger, samt kommersielle og lettindustrielle miljøer:
vakuuttaa täten yksinomaista vastuutaan, että jäljempänä kuvatut asuinrakennuksiin, pientaloisuuskäyttöön ja kaupalliseen käyttöön tarkoitettuihin ilmastointilaitteisiin ja lämpöpumpuihin on omalla vastuullaan vastattava, että nämä ilmastointilaitteet ja lämpöpumput on tarkoitettu käytettäväksi vain omalla vastuullaan:
tímto na vlastní odpovědnost prohlašuje, že níže popsané klimatizační jednotky a tepelné čerpadla pro použití v obytných prostedích, komerčních prostedích a prostedích lehkeho prmyslu:
týmto na svoju výlučnú zodpovednosť vyhlasuje, že nasledovné klimatizačné jednotky a tepelné čerpadlá určené na používanie v obytných a obchodných priestoroch a v prostredí ľahkého priemyslu:
alulírott kizárólagos felelősségére nyilatkozok, hogy az alábbi lakossági, kereskedelmi és kisipari környezetben való használatra szánt klímaberendezések és hőszivattyúk:
izjavlja pod izključno lastno odgovornostjo, da so spodaj navedene klimatske naprave in toplotne črpalke, namenjene uporabi v stanovanjskih, komercialnih in lahkoindustrijskih okoljih:
declară, prin prezenta, pe proprie răspundere, faptul că aparatele de climatizare și pompele de căldură descrise mai jos și destinate utilizării în medii rezidențiale, comerciale și din industria ușoară:
kinnitab käesolevaga oma ainuvastutusel, et allpool toodud kliimaseadmed ja soojuspumbad on mõeldud kasutamiseks elu-, äri- ja kergtööstuskeskkondades:
ar so, vienpersoniski uzņemoties atbildību, paziņo, ka tālāk aprakstītie gaisa kondicionētāji un siltumsūkņi ir paredzēti lietošanai dzīvojamajās, komercdarbības un vieglās rūpniecības telpās.
šiuo vien tik savo atsakomybe pareiškia, kad toliau apibūdinti oro kondicionieriai ir šilumos siurbiai skirti naudoti gyvenamosiose, komercinėse ir lengvosios pramonės aplinkose:
ovime izjavljuje pod isključivom odgovornostjo da su klimatizacijski uređaji i toplinske dizalice opisane u nastavku namijenjeni za upotrebu u stambenim i poslovnim okruženjima te okruženjima lake industrije:
ovim izjavljuje na svoju isključivu odgovornost da su klima-uređaji i toplotne pumpe opisane u daljem tekstu za upotrebu u stambenim, komercijalnim okruženjima i okruženjima sa lakom industrijom:
настоящим заявляет и берет на себя исключительную ответственность за то, что кондиционеры и тепловые насосы, описанные ниже и предназначенные для эксплуатации в жилых помещениях, торговых залах и на предприятиях легкой промышленности:
чим заявляє, беручи на себе повну відповідальність за це, що кондиціонери й теплові насоси, описані нижче й призначені для використання в житлових приміщеннях, торговельних залах і на підприємствах легкої промисловості:

MITSUBISHI ELECTRIC, MFZ-KT25VG, MFZ-KT35VG, MFZ-KT50VG, MFZ-KT60VG

Note: Its serial number is on the nameplate of the product.
Hinweis: Die Seriennummer befindet sich auf dem Kennschild des Produkts.
Remarque : Le numéro de série de l'appareil se trouve sur la plaque du produit.
Opmerking: het serienummer staat op het naamplaatje van het product.
Nota: El número de serie se encuentra en la placa que contiene el nombre del producto.
Nota: il numero di serie si trova sulla targhetta del prodotto.
Σημείωση: Ο σειριακός του αριθμός βρίσκεται στην πινακίδα ονόματος του προϊόντος.
Nota: o número de série encontra-se na placa que contém o nome do produto.
Bemærk: Seriennummeret står på produktets fabriksskilt.
Obs: Serienumret finns på produktens namnplåt.
Not: Seri numarasi ürünün isim plakasında yer alır.
Забелужка: Серийный номер е на табелката на продукта.
Uwaga: Numer seryjny znajduje się na tabliczce znamionowej produktu.
Merk: Seriennummeret finnes seg på navneplaten til produktet.

Huomautus: Sarjanumero on merkitty laitteen arvokilpeen.
Poznámka: Příslušné sériové číslo se nachází na štítku produktu.
Poznámka: Výrobné číslo sa nachádza na typovom štítku výrobku.
Megjegyzés: A sorozatszám a termék adattábláján található.
Opomba: serijska številka je zapisana na tipski ploščici enote.
Notă: Numărul de serie este specificat pe plăcuța indicatoare a produsului.
Márkus: Seerianumber asub toote andmesildil.
Piezīme: Sērijas numurs ir norādīts uz ierīces datu plāksnītes.
Pastaba: Serijos numeris nurodytas gaminio vardinųjų duomenų lentelėje.
Napomena: serijski broj nalazi se na natpisnoj pločici proizvoda.
Napomena: Serijski broj nalazi se na nazivnoj pločici proizvoda.
Примечание: серийный номер указан на паспортное табличке изделия.
Примітка: Серійний номер вказано на паспортній табличці виробу.

Directives	Direttive	Direktifler	Směrnice	Direktiivid	Директивы
Richtlijnen	Οδηγίες	Директиви	Smernice	Direktīvas	Директиви
Directives	Directivas	Dyrektivy	Irányelvek	Direktivos	
Richtlijnen	Direktiver	Direktivy	Direktive	Direktive	
Directivas	Direktiv	Direktiivit	Directive	Direktive	

2014/35/EU: Low Voltage Directive
2006/42/EC: Machinery Directive
2014/30/EU: Electromagnetic Compatibility Directive
2011/65/EU: RoHS

Issued: 7 May, 2019
JAPAN

Katsuo YABUTA
Senior Manager, Quality Assurance Department

MITSUBISHI ELECTRIC CORPORATION

HEAD OFFICE: TOKYO BUILDING, 2-7-3, MARUNOUCHI, CHIYODA-KU, TOKYO 100-8310, JAPAN

RH79A019WB3