

Packaged Air Conditioners

Indoor unit

PKA-M-HA

PKA-M-HAL

PCA-M-KA

OPERATION MANUAL	FOR USER	English
BEDIENUNGSHANDBUCH	FÜR BENUTZER	Deutsch
MANUEL D'UTILISATION	POUR L'UTILISATEUR	Français
BEDIENINGSHANDLEIDING	VOOR DE GEBRUIKER	Nederlands
MANUAL DE INSTRUCCIONES	PARA EL USUARIO	Español
ISTRUZIONI DI FUNZIONAMENTO	PER L'UTENTE	Italiano
ΕΓΧΕΙΡΙΔΙΟ ΟΔΗΓΙΩΝ ΧΡΗΣΕΩΣ	ΓΙΑ ΤΟΝ ΧΡΗΣΤΗ	Ελληνικά
MANUAL DE OPERAÇÃO	PARA O UTILIZADOR	Português
DRIFTSMANUAL	TIL BRUGER	Dansk
DRIFTSMANUAL	FÖR ANVÄNDAREN	Svenska
İŞLETME ELKİTABI	KULLANICI İÇİN	Türkçe
РУКОВОДСТВО ПО ЭКСПЛУАТАЦИИ	ДЛЯ ПОЛЬЗОВАТЕЛЯ	Русский
ПОСІБНИК З ЕКСПЛУАТАЦІЇ	ДЛЯ КОРИСТУВАЧА	Українська
РЪКОВОДСТВО ЗА ЕКСПЛОАТАЦИЯ	ЗА ПОТРЕБИТЕЛЯ	Български
INSTRUKCJA OBSŁUGI	INFORMACJA DLA UŻYTKOWNIKA	Polski
BRUKSANVISNING	FOR BRUKER	Norsk
KÄYTTÖOPAS	KÄYTTÄJÄLLE	Suomi
PROVOZNI PŘÍRUČKA	PRO UŽIVATELE	Čeština
NÁVOD NA OBSLUHU	PRE POUŽÍVATEĽA	Slovenčina
HASZNÁLATI KÉZIKÖNYV	A FELHASZNÁLÓNAK	Magyar
NAVODILA ZA UPORABO	ZA UPORABNIKA	Slovenščina
MANUAL DE UTILIZARE	PENTRU UTILIZATOR	Română
KASUTUSJUHEND	KASUTAJALE	Eesti
LIETOŠANAS ROKASGRĀMATA	LIETOTĀJIEM	Latviski
NAUDOJIMO VADOVAS	SKIRTA NAUDOTOJUI	Lietuviškai
PRIRUČNIK ZA RUKOVANJE	ZA KORISNIKA	Hrvatski
UPUTSTVO ZA RUKOVANJE	ZA KORISNIKA	Srpski

1. Safety Precautions	1	5. Emergency Operation for Wireless Remote-controller	9
2. Parts Names	2	6. Care and Cleaning.....	10
3. Operation.....	6	7. Trouble Shooting	11
4. Timer	9	8. Specifications	13

Note



Fig. 1

This symbol mark is for EU countries only.

This symbol mark is according to the directive 2012/19/EU Article 14 Information for users and Annex IX, and/or to the directive 2006/66/EC Article 20 Information for end-users and Annex II.

Your MITSUBISHI ELECTRIC product is designed and manufactured with high quality materials and components which can be recycled and/or reused. This symbol means that electrical and electronic equipment, batteries and accumulators, at their end-of-life, should be disposed of separately from your household waste. If a chemical symbol is printed beneath the symbol (Fig. 1), this chemical symbol means that the battery or accumulator contains a heavy metal at a certain concentration.

This will be indicated as follows: Hg: mercury (0.0005%), Cd: cadmium (0.002%), Pb: lead (0.004%)

In the European Union there are separate collection systems for used electrical and electronic products, batteries and accumulators.

Please, dispose of this equipment, batteries and accumulators correctly at your local community waste collection/recycling centre.

Please, help us to conserve the environment we live in!

Note:

The phrase "Wired remote controller" in this operation manual refers only to the PAR-32MAA.

If you need any information for the other remote controller, please refer to the instruction book included in this box.

1. Safety Precautions

- ▶ Before installing the unit, make sure you read all the "Safety Precautions".
- ▶ The "Safety Precautions" provide very important points regarding safety. Make sure you follow them.
- ▶ Please report to or take consent by the supply authority before connection to the system.

MEANINGS OF SYMBOLS DISPLAYED ON INDOOR UNIT AND/OR OUTDOOR UNIT

	WARNING (Risk of fire)	This mark is for R32 refrigerant only. Refrigerant type is written on nameplate of outdoor unit. In case that refrigerant type is R32, this unit uses a flammable refrigerant. If refrigerant leaks and comes in contact with fire or heating part, it will create harmful gas and there is risk of fire.
	Read the OPERATION MANUAL carefully before operation.	
	Service personnel are required to carefully read the OPERATION MANUAL and INSTALLATION MANUAL before operation.	
	Further information is available in the OPERATION MANUAL, INSTALLATION MANUAL, and the like.	

Symbols used in the text

Warning:

Describes precautions that should be observed to prevent danger of injury or death to the user.

Caution:

Describes precautions that should be observed to prevent damage to the unit.

Warning:

- There appliances are not accessible to the general public.
- The unit must not be installed by the user. Ask the dealer or an authorized company to install the unit. If the unit is installed improperly, water leakage, electric shock or fire may result.
- Do not stand on, or place any items on the unit.
- Do not splash water over the unit and do not touch the unit with wet hands. An electric shock may result.
- Do not spray combustible gas close to the unit. Fire may result.
- Do not place a gas heater or any other open-flame appliance where it will be exposed to the air discharged from the unit. Incomplete combustion may result.
- Do not remove the front panel or the fan guard from the outdoor unit when it is running.
- When you notice exceptionally abnormal noise or vibration, stop operation, turn off the power switch, and contact your dealer.
- Never insert fingers, sticks etc. into the intakes or outlets.
- If you detect odd smells, stop using the unit, turn off the power switch and consult your dealer. Otherwise, a breakdown, electric shock or fire may result.
- This air conditioner is NOT intended for use by children or infirm persons without supervision.
- Young children must be supervised to ensure that they do not play with the air conditioner.
- If the refrigeration gas blows out or leaks, stop the operation of the air conditioner, thoroughly ventilate the room, and contact your dealer.
- This appliance is intended to be used by expert or trained users in shops, in light industry and on farms, or for commercial use by lay persons.
- This appliance can be used by children aged from 8 years and above and persons with reduced physical, sensory or mental capabilities or lack of experience and knowledge if they have been given supervision or instruction concerning use of the appliance in a safe way and understand the hazards involved. Children shall not play with the appliance.

Symbols used in the illustrations

: Indicates a part which must be grounded.

Cleaning and user maintenance shall not be made by children without supervision.

- Children should be supervised to ensure that they do not play with the appliances.
- This appliance is not intended for use by persons (including children) with reduced physical, sensory or mental capabilities, or lack of experience and knowledge, unless they have been given supervision or instruction concerning use of the appliance by a person responsible for their safety.
- When installing or relocating, or servicing the air conditioner, use only the specified refrigerant written on outdoor unit to charge the refrigerant lines. Do not mix it with any other refrigerant and do not allow air to remain in the lines.
If air is mixed with the refrigerant, then it can be the cause of abnormal high pressure in the refrigerant line, and may result in an explosion and other hazards.
The use of any refrigerant other than that specified for the system will cause mechanical failure or system malfunction or unit breakdown. In the worst case, this could lead to a serious impediment to securing product safety.
- This unit should be installed in rooms which exceed the floor space specified in outdoor unit installation manual.
Refer to outdoor unit installation manual.
- Do not use means to accelerate the defrosting process or to clean, other than those recommended by the manufacturer.
- The appliance shall be stored in a room without continuously operating ignition sources (for example: open flames, an operating gas appliance or an operating electric heater).
- Do not pierce or burn.
- Be aware that refrigerants may not contain an odour.

1. Safety Precautions

⚠ Caution:

- Do not use any sharp object to push the buttons, as this may damage the remote controller.
- Never block or cover the indoor or outdoor unit's intakes or outlets.

Disposing of the unit

When you need to dispose of the unit, consult your dealer.

2. Parts Names

■ Indoor Unit

	PKA-M-HA(L)	PCA-M-KA
Fan speed	3 speeds + Auto	4 speeds + Auto
Vane	Auto with swing	Auto with swing
Louver	Manual	Manual
Filter	Normal	Long-life
Filter cleaning indication	100 hr	2,500 hr
Wireless remote controller model No. setting	002	001

■ PKA-M-HA(L)

Wall Mounted

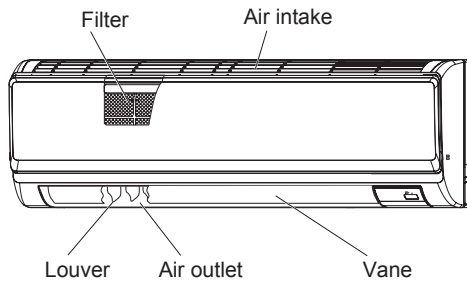

■ PCA-M-KA

Ceiling Suspended

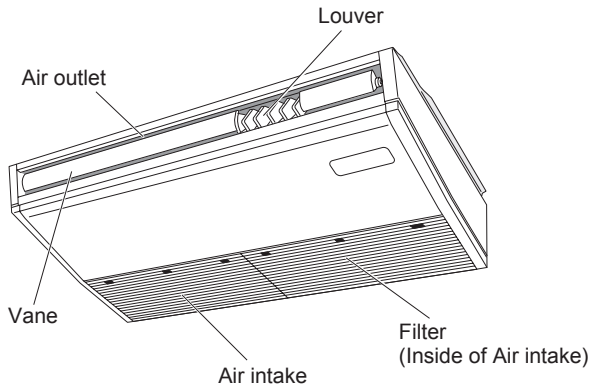

2. Parts Names

■ Wired Remote Controller

Controller interface

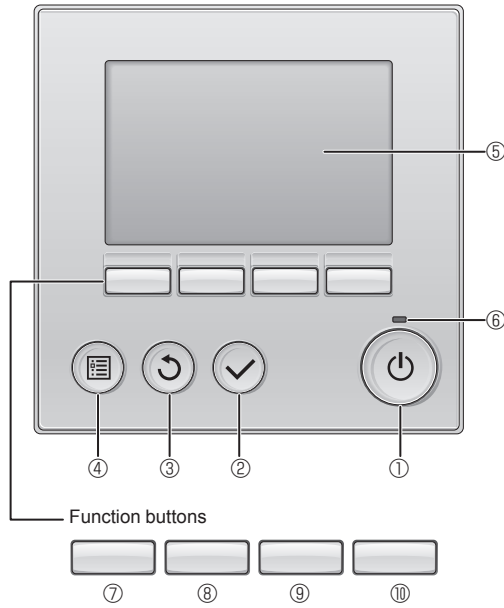

The functions of the function buttons change depending on the screen.

Refer to the button function guide that appears at the bottom of the LCD for the functions they serve on a given screen.

When the system is centrally controlled, the button function guide that corresponds to the locked button will not appear.

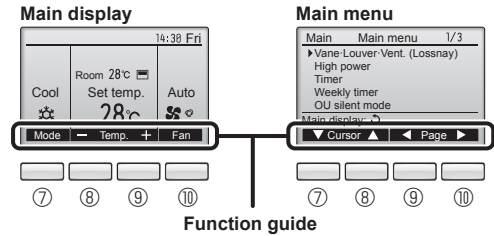

EN

① [ON/OFF] button

Press to turn ON/OFF the indoor unit.

② [SELECT] button

Press to save the setting.

③ [RETURN] button

Press to return to the previous screen.

④ [MENU] button

Press to bring up the Main menu.

⑤ Backlit LCD

Operation settings will appear.

When the backlight is off, pressing any button turns the backlight on and it will stay lit for a certain period of time depending on the screen.

When the backlight is off, pressing any button turns the backlight on and does not perform its function. (except for the [ON/OFF] button)

⑥ ON/OFF lamp

This lamp lights up in green while the unit is in operation. It blinks while the remote controller is starting up or when there is an error.

⑦ Function button [F1]

Main display: Press to change the operation mode.

Main menu: Press to move the cursor down.

⑧ Function button [F2]

Main display: Press to decrease temperature.

Main menu: Press to move the cursor up.

⑨ Function button [F3]

Main display: Press to increase temperature.

Main menu: Press to go to the previous page.

⑩ Function button [F4]

Main display: Press to change the fan speed.

Main menu: Press to go to the next page.

2. Parts Names

Display

The main display can be displayed in two different modes: "Full" and "Basic". The factory setting is "Full". To switch to the "Basic" mode, change the setting on the Main display setting. (Refer to operation manual included with remote controller.)

<Full mode>

* All icons are displayed for explanation.

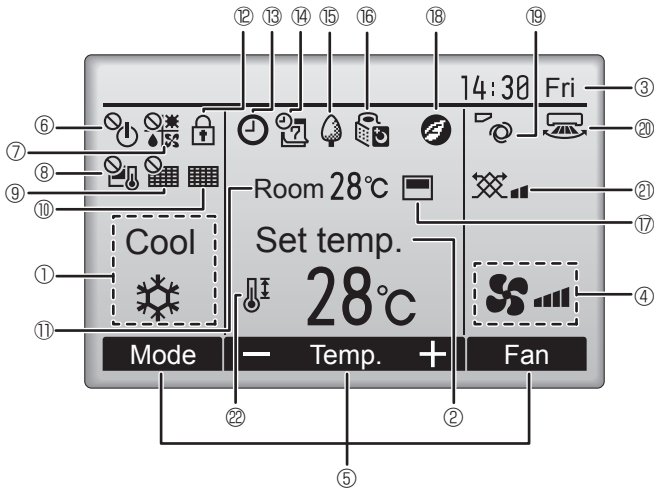

<Basic mode>

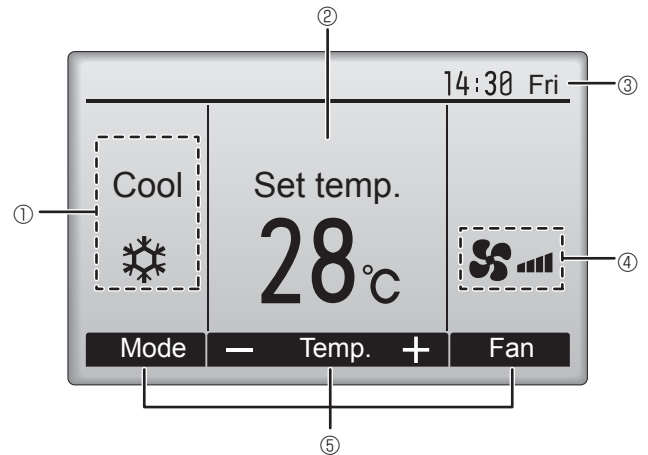

① Operation mode

Indoor unit operation mode appears here.

② Preset temperature

Preset temperature appears here.

③ Clock (See the Installation Manual.)

Current time appears here.

④ Fan speed

Fan speed setting appears here.

⑤ Button function guide

Functions of the corresponding buttons appear here.



Appears when the ON/OFF operation is centrally controlled.



Appears when the operation mode is centrally controlled.



Appears when the preset temperature is centrally controlled.



Appears when the filter reset function is centrally controlled.



Indicates when filter needs maintenance.

⑪ Room temperature (See the Installation Manual.)

Current room temperature appears here.



Appears when the buttons are locked.



Appears when the On/Off timer, Night setback, or Auto-off timer function is enabled.



Appears when the timer is disabled by the centralized control system.



Appears when the Weekly timer is enabled.



Appears while the units are operated in the energy-save mode. (Will not appear on some models of indoor units)



Appears while the outdoor units are operated in the silent mode.



Appears when the built-in thermistor on the remote controller is activated to monitor the room temperature (⑪).



Appears when the thermistor on the indoor unit is activated to monitor the room temperature.



Appears when the units are operated in the energy-save mode with 3D i-see Sensor.



Indicates the vane setting.



Indicates the louver setting.



Indicates the ventilation setting.



Appears when the preset temperature range is restricted.

Most settings (except ON/OFF, mode, fan speed, temperature) can be made from the Menu screen. (Refer to operation manual included with remote controller.)

2. Parts Names

■ Wireless Remote-Controller [PKA-M·HAL only]

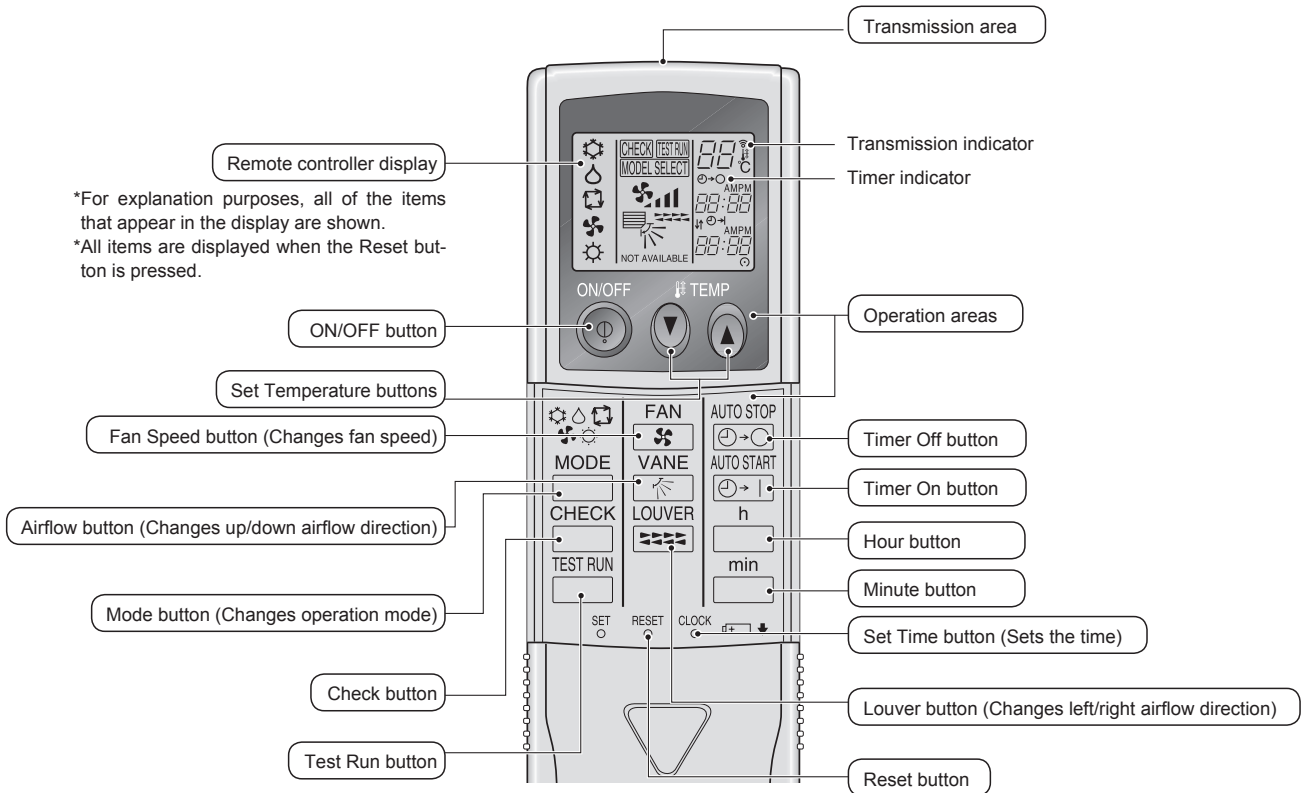

Note (Only for wireless remote controller):

- When using the wireless remote controller, point it towards the receiver on the indoor unit.
- If the remote controller is operated within approximately 2 minutes after power is supplied to the indoor unit, the indoor unit may beep twice as the unit is performing the initial automatic check.
- The indoor unit beeps to confirm that the signal transmitted from the remote controller has been received. Signals can be received up to approximately 7 meters in a direct line from the indoor unit in an area 45° to the left and right of the unit. However, illumination such as fluorescent lights and strong light can affect the ability of the indoor unit to receive signals.
- If the operation lamp near the receiver on the indoor unit is blinking, the unit needs to be inspected. Consult your dealer for service.
- Handle the remote controller carefully! Do not drop the remote controller or subject it to strong shocks. In addition, do not get the remote controller wet or leave it in a location with high humidity.
- To avoid misplacing the remote controller, install the holder included with the remote controller on a wall and be sure to always place the remote controller in the holder after use.

■ Outdoor unit

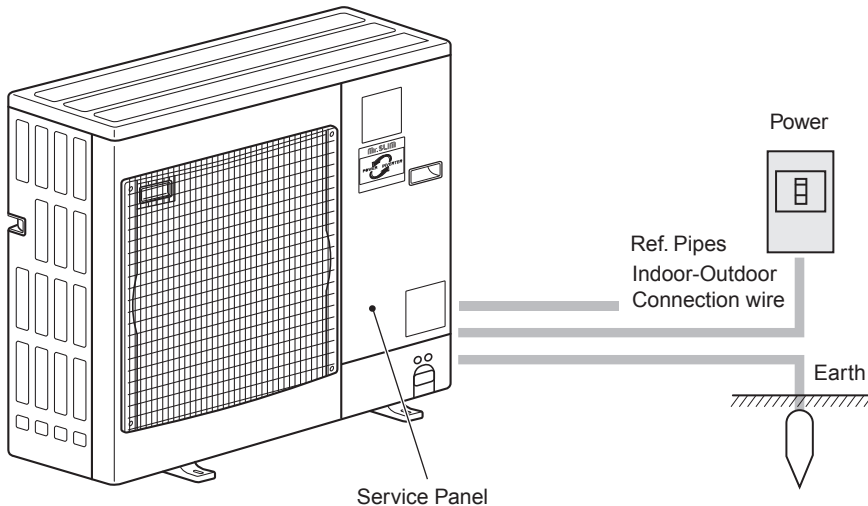

Battery installation/replacement

1. Remove the top cover, insert 2 AAA batteries, and then install the top cover.

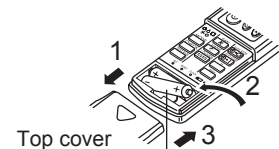

Two AAA batteries
Insert the negative (-)
end of each battery first.
Install the batteries in
the correct directions
(+, -)!

2. Press the Reset button.

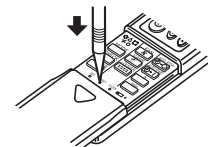

Press the Reset button
with an object that has a
narrow end.

3. Operation

■ About the operation method, refer to the operation manual that comes with each remote controller.

3.1. Turning ON/OFF

[ON]

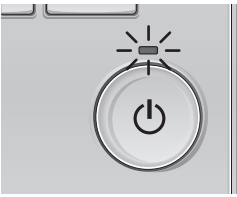

Press the [ON/OFF] button. The ON/OFF lamp will light up in green, and the operation will start.

[OFF]

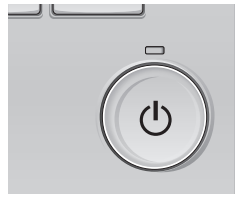

Press the [ON/OFF] button again. The ON/OFF lamp will come off, and the operation will stop.

Note:

Even if you press the ON/OFF button immediately after shutting down the operation in progress, the air conditioner will not start for about 3 minutes. This is to prevent the internal components from being damaged.

■ Operation status memory

	Remote controller setting
Operation mode	Operation mode before the power was turned off
Preset temperature	Preset temperature before the power was turned off
Fan speed	Fan speed before the power was turned off

■ Settable preset temperature range

Operation mode	Preset temperature range
Cool/Dry	19 ~ 30 °C
Heat	17 ~ 28 °C
Auto	19 ~ 28 °C
Fan/Ventilation	Not settable

EN

3.2. Mode Selection

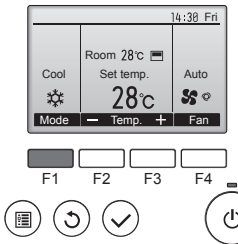

Press the [F1] button to go through the operation modes in the order of "Cool", "Dry", "Fan", "Auto", and "Heat". Select the desired operation mode.

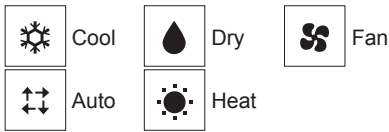

- Operation modes that are not available to the connected outdoor unit models will not appear on the display.

What the blinking mode icon means

The mode icon will blink when other indoor units in the same refrigerant system (connected to the same outdoor unit) are already operated in a different mode. In this case, the rest of the unit in the same group can only be operated in the same mode.

Automatic operation

- According to a set temperature, cooling operation starts if the room temperature is too hot and heating operation starts if the room temperature is too cold.
- During automatic operation, if the room temperature changes and remains 2.0 °C or more above the set temperature for 15 minutes, the air conditioner switches to cool mode. In the same way, if the room temperature remains 2.0 °C or more below the set temperature for 15 minutes, the air conditioner switches to heat mode.

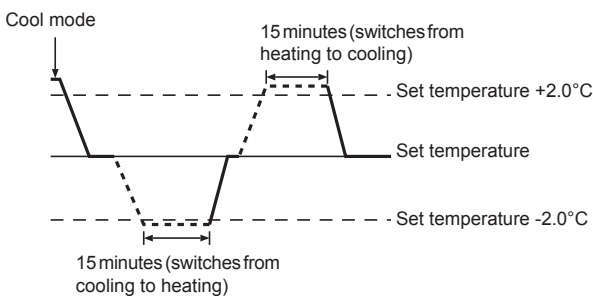

<Dual set point>

Note:

- This function cannot be set depending on the outdoor unit to be connected.

When the operation mode is set to the Auto (dual set point) mode, two preset temperatures (one each for cooling and heating) can be set. Depending on the room temperature, indoor unit will automatically operate in either the Cool or Heat mode and keep the room temperature within the preset range.

For details on how to operate, refer to manual of remote controller.

Information for multi system air conditioner (Outdoor unit: MXZ series)

- Multi system air conditioner (Outdoor unit: MXZ series) can connect two or more indoor units with one outdoor unit. According to the capacity, 2 or more units can operate simultaneously.
- When you try to operate 2 or more indoor units with 1 outdoor unit simultaneously, one for the cooling and the other for heating, the operation mode of the indoor unit that operates earlier is selected. The other indoor units that will start the operation later cannot operate, indicating an operation state in blinking. In this case, please set all the indoor units to the same operation mode.
- There might be a case that the indoor unit, which is operating in "Auto" mode. Cannot change over to the operating mode "Cool"/"Heat" and becomes a state of standby.
- When indoor unit starts the operation while the defrosting of outdoor unit is being done, it takes a few minutes (max. about 15 minutes) to blow out the warm air.
- In the heating operation, though indoor unit that does not operate may get warm or the sound of refrigerant flowing may be heard, they are not malfunction. The reason is that the refrigerant continuously flows into it.

3. Operation

3.3. Temperature setting

<Cool, Dry, Heat, and Auto>

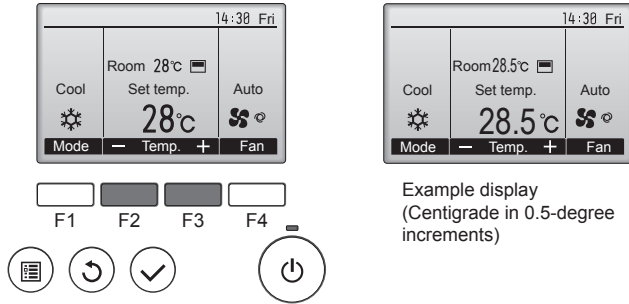

Example display
(Centigrade in 0.5-degree increments)

Press the [F2] button to decrease the preset temperature, and press the [F3] button to increase.

- Refer to the table on page 6 for the settable temperature range for different operation modes.
- Preset temperature range cannot be set for Fan/Ventilation operation.
- Preset temperature will be displayed either in Centigrade in 0.5- or 1-degree increments, or in Fahrenheit, depending on the indoor unit model and the display mode setting on the remote controller.

3.4. Fan speed setting

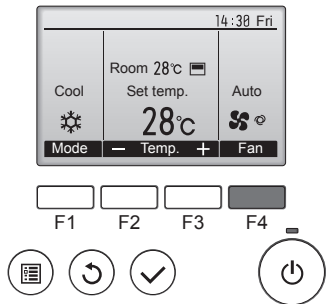

Press the [F4] button to go through the fan speeds in the following order.

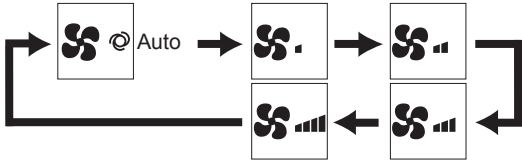

- The available fan speeds depend on the models of connected indoor units.

Note:

- The number of available fan speeds depends on the type of unit connected. Note also that some units do not provide an "Auto" setting.
- In the following cases, the actual fan speed generated by the unit will differ from the speed shown the remote controller display.
 1. While the display is showing "STAND BY" or "DEFROST".
 2. When the temperature of the heat exchanger is low in the heat mode. (e.g. immediately after heat operation starts)
 3. In HEAT mode, when room temperature is higher than the temperature setting.
 4. In COOL mode, when room temperature is lower than the temperature setting.
 5. When the unit is in DRY mode.

■ Automatic fan speed setting (For wireless remote controller)

It is necessary to set for wireless remote controller only when automatic fan speed is not set at default setting.

It is not necessary to set for wired remote controller with automatic fan speed at default setting.

- ① Press the SET button with something sharp at the end.

Operate when display of remote controller is off.

MODEL SELECT blinks and Model No. is lighted (A).

- ② Press the AUTO STOP button.

MODEL SELECT blinks and setting No. is lighted (B).

(Setting No.01: without automatic fan speed)

- ③ Press the temp. (+) (-) buttons to set the setting No.02.

(Setting No.02: with automatic fan speed)

If you mistook the operation, press the ON/OFF button and operate again from procedure ②.

- ④ Press the SET button with something sharp at the end.

MODEL SELECT and Model No. are lighted for 3 seconds, then turned off.

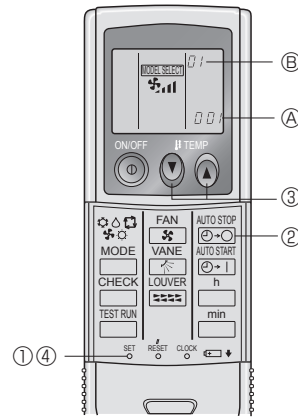

3.5. Airflow direction setting

3.5.1 Navigating through the Main menu

<Accessing the Main menu>

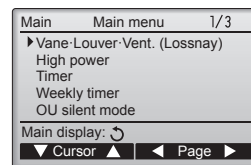

Press the [MENU] button.
The Main menu will appear.

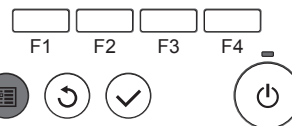

<Item selection>

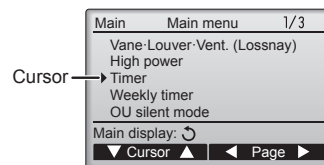

Press [F1] to move the cursor down.
Press [F2] to move the cursor up.

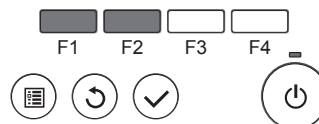

3. Operation

<Navigating through the pages>

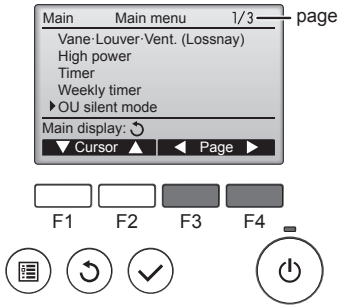

Press [F3] to go to the previous page.
Press [F4] to go to the next page.

<Saving the settings>

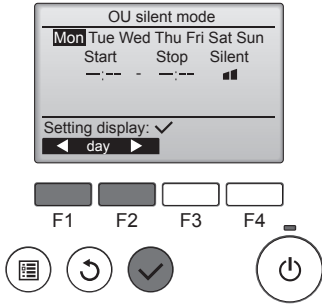

Select the desired item, and press the [SELECT] button.

The screen to set the selected item will appear.

<Exiting the Main menu screen>

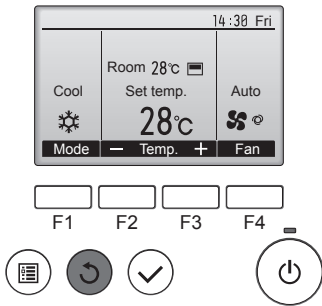

Press the [RETURN] button to exit the Main menu and return to the Main display.

If no buttons are touched for 10 minutes, the screen will automatically return to the Main display. Any settings that have not been saved will be lost.

<Display of unsupported functions>

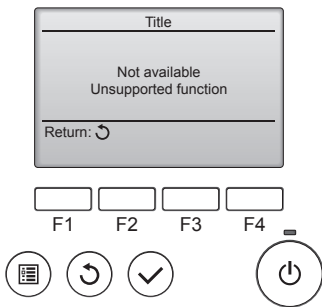

The message at left will appear if the user selects a function not supported by the corresponding indoor unit model.

3.5.2 Vane-Vent. (Lossnay)

<Accessing the menu>

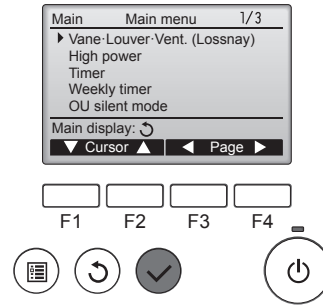

Select "Vane-Louver-Vent. (Lossnay)" from the Main menu (refer to page 7), and press the [SELECT] button.

<Vane setting>

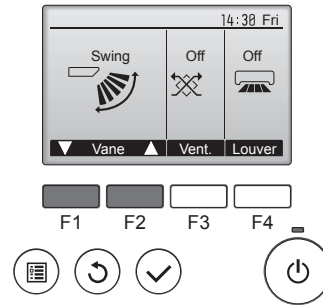

Press the [F1] or [F2] button to go through the vane setting options: "Auto", "Step 1", "Step 2", "Step 3", "Step 4", "Step 5" and "Swing".

Select the desired setting.

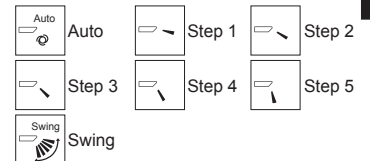

Select "Swing" to move the vanes up and down automatically.

When set to "Step 1" through "Step 5", the vane will be fixed at the selected angle.

- **1h** under the vane setting icon
This icon will appear when the vane is set to "Step 2" to "Step 5" and the fan operates at "Mid 1" to "Low" speed during cooling or dry operation (depends on the model).

The icon will go off in an hour, and the vane setting will automatically change.

<Vent. setting>

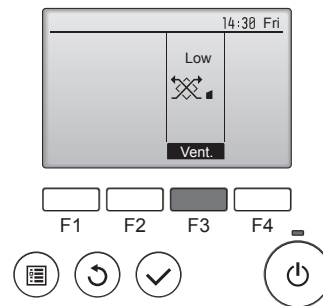

Press the [F3] button to go through the ventilation setting options in the order of "Off", "Low", and "High".

* Settable only when LOSSNAY unit is connected.



- The fan on some models of indoor units may be interlocked with certain models of ventilation units.

<Returning to the Main menu>

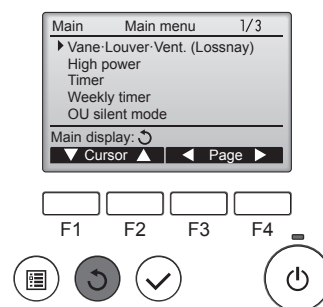

Press the [RETURN] button to go back to the Main menu.

3. Operation

Note:

- During swing operation, the directional indication on the screen does not change in sync with the directional vanes on the unit.
- Available directions depend on the type of unit connected.
- In the following cases, the actual air direction will differ from the direction indicated on the remote controller display.
 1. While the display is in "STAND BY" or "DEFROST" states.
 2. Immediately after starting heat mode (while the system is waiting for the mode change to take effect).
 3. In heat mode, when room temperature is higher than the temperature setting.

<[Manual] To Change the Airflow's Left/Right Direction>

- * The louver button cannot be used.
- Model PKA-M-HA(L)
 - Stop the unit operation, hold the lever of the louver, and adjust to the desired direction.
 - * Do not set to the inside direction when the unit is in the cooling or drying mode because there is a risk of condensation and water dripping.

⚠ Caution:
To prevent falls, maintain a stable footing when operating the unit.

3.6. Ventilation

- For LOSSNAY combination
- The following 2 patterns of operation is available.
 - Run the ventilator together with indoor unit.
 - Run the ventilator independently.

Note: (for wireless remote controller)

- Running the ventilator independently is not available.
- No indication on the remote controller.

EN

4. Timer

4.1. For Wired Remote-controller

- Timer functions are different by each remote controller.
- For details on how to operate the remote controller, refer to the appropriate operation manual included with each remote controller.

5. Emergency Operation for Wireless Remote-controller

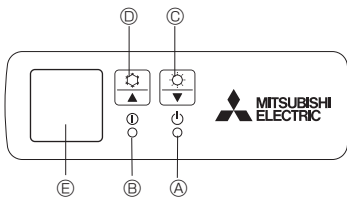

Fig. 5-1

For PKA-M-HA(L)

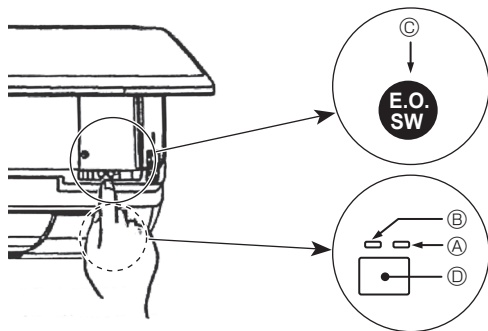

Fig. 5-2

When the remote controller cannot be used

When the batteries of the remote controller run out or the remote controller malfunctions, the emergency operation can be done using the emergency buttons.

- [Fig. 5-1] ① DEFROST/STAND BY lamp
 ② Operation lamp
 ③ Emergency operation switch (heating)
 ④ Emergency operation switch (cooling)
 ⑤ Receiver

Starting operation

- To operate the cooling mode, press the ⚙ button ④ for more than 2 seconds.
- To operate the heating mode, press the ⚙ button ③ for more than 2 seconds.

Stopping operation

- To stop operation, press the ⚙ button ④ or the ⚙ button ③ for more than 2 seconds.

- [Fig. 5-2] ① DEFROST/STAND BY lamp (Orange)
 ② Operation lamp (Green)
 ③ Emergency operation switch (cooling/heating)
 ④ Receiver

- Each press of the emergency operation switch will toggle the operation mode.
- Check "COOL/HEAT" with the operation monitor display. (The orange lamp ① follows this monitor display for 5 seconds after pressing the emergency operation switch.)

[Heat pump type]



[Cooling only type]

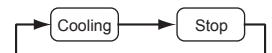

Operation Monitor Display

	GREEN	ORANGE	
STOP	○	○	The orange lamp follows the switch operation as indicated at the left for 5 seconds, and then it will return to the normal display.
COOL	●	○	
HEAT	●	●	

○ : Turning off ● : Lighting

Note:

- Details of emergency mode are as shown below.

Operation mode	COOL	HEAT
Set temperature	24°C	24°C
Fan speed	High	High
Airflow direction	Horizontal	Downward 4 (5)

6. Care and Cleaning

■ Filter information

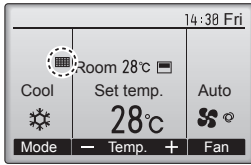

The filter sign icon will appear on the Main display in the Full mode when it is time to clean the filters.

Wash, clean, or replace the filters when this sign appears. Refer to the indoor unit Instructions Manual for details.

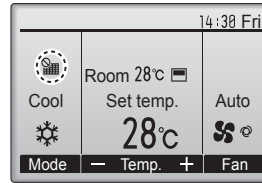

When the filter sign icon with a prohibition sign is displayed on the Main display in the Full mode, the system is centrally controlled and the filter sign cannot be reset.

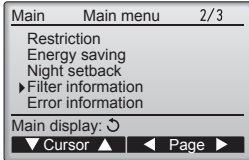

Select "Filter information" from the Main menu (refer to page 7), and press the [SELECT] button.

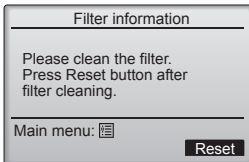
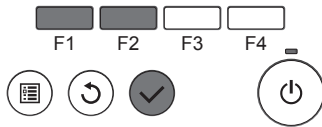

Press the [F4] button to reset filter sign. Refer to the indoor unit Instructions Manual for how to clean the filter.

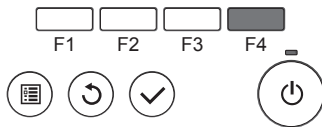

Select "OK" with the [F4] button.

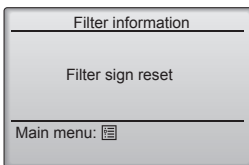
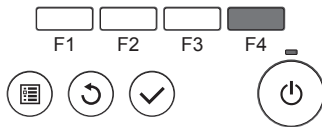

A confirmation screen will appear.

Navigating through the screens

- To go back to the Main menu..... [MENU] button
- To return to the previous screen [RETURN] button

If two or more indoor units are connected, filter cleaning timing for each unit may be different, depending on the filter type.

The icon will appear when the filter on the main unit is due for cleaning.

When the filter sign is reset, the cumulative operation time of all units will be reset.

The icon is scheduled to appear after a certain duration of operation, based on the premise that the indoor units are installed in a space with ordinary air quality. Depending on the air quality, the filter may require more frequent cleaning.

The cumulative time at which filter needs cleaning depends on the model.

- This indication is not available for wireless remote controller.

EN

► Cleaning the filters

- Clean the filters using a vacuum cleaner. If you do not have a vacuum cleaner, tap the filters against a solid object to knock off dirt and dust.
- If the filters are especially dirty, wash them in lukewarm water. Take care to rinse off any detergent thoroughly and allow the filters to dry completely before putting them back into the unit.

⚠ Caution:

- Do not dry the filters in direct sunlight or by using a heat source, such as an electric heater: this may warp them.
- Do not wash the filters in hot water (above 50°C), as this may warp them.
- Make sure that the air filters are always installed. Operating the unit without air filters can cause malfunction.

⚠ Caution:

- Before you start cleaning, stop operation and turn OFF the power supply.
- Indoor units are equipped with filters to remove the dust of sucked-in air. Clean the filters using the methods shown in the following sketches.

6. Care and Cleaning

PKA-M-HA(L)

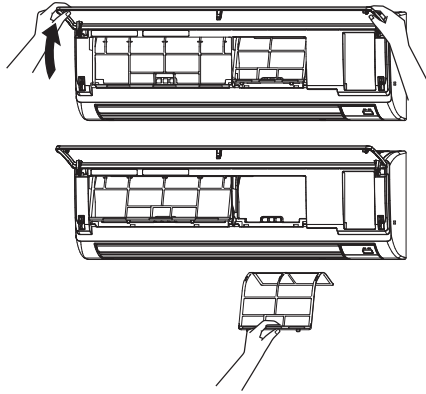

- ① Pull both the bottom corners of the intake grille to open the grille, then lift the filter.

PCA-M-KA

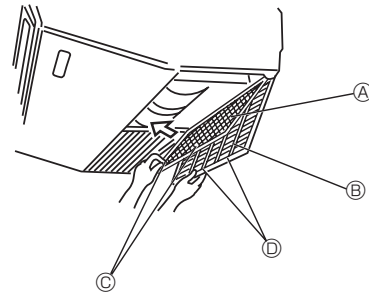

- ① Open the intake grille.
② Hold the knob on the filter then pull the filter up in the direction of an arrow. To replace the filter after cleaning, be sure to insert the filter far enough until it fits into the stopper.

- Ⓐ Filter
Ⓑ Intake Grille
Ⓒ Knob
Ⓓ Stopper

EN

7. Trouble Shooting

Having trouble?	Here is the solution. (Unit is operating normally.)
Air conditioner does not heat or cool well.	<ul style="list-style-type: none"> ■ Clean the filter. (Airflow is reduced when the filter is dirty or clogged.) ■ Check the temperature adjustment and adjust the set temperature. ■ Make sure that there is plenty of space around the outdoor unit. Is the indoor unit air intake or outlet blocked? ■ Has a door or window been left open?
When heating operation starts, warm air does not blow from the indoor unit soon.	<ul style="list-style-type: none"> ■ Warm air does not blow until the indoor unit has sufficiently warmed up.
During heating mode, the air conditioner stops before the set room temperature is reached.	<ul style="list-style-type: none"> ■ When the outdoor temperature is low and the humidity is high, frost may form on the outdoor unit. If this occurs, the outdoor unit performs a defrosting operation. Normal operation should begin after approximately 10 minutes.
Airflow direction changes during operation or airflow direction cannot be set.	<ul style="list-style-type: none"> ■ During cooling mode, the vanes automatically move to the horizontal (down) position after 1 hour when the down (horizontal) airflow direction is selected. This is to prevent water from forming and dripping from the vanes. ■ During heating mode, the vanes automatically move to the horizontal airflow direction when the airflow temperature is low or during defrosting mode.
When the airflow direction is changed, the vanes always move up and down past the set position before finally stopping at the position.	<ul style="list-style-type: none"> ■ When the airflow direction is changed, the vanes move to the set position after detecting the base position.
A flowing water sound or occasional hissing sound is heard.	<ul style="list-style-type: none"> ■ These sounds can be heard when refrigerant is flowing in the air conditioner or when the refrigerant flow is changing.
A cracking or creaking sound is heard.	<ul style="list-style-type: none"> ■ These sounds can be heard when parts rub against each other due to expansion and contraction from temperature changes.
The room has an unpleasant odor.	<ul style="list-style-type: none"> ■ The indoor unit draws in air that contains gases produced from the walls, carpeting, and furniture as well as odors trapped in clothing, and then blows this air back into the room.
A white mist or vapor is emitted from the indoor unit.	<ul style="list-style-type: none"> ■ If the indoor temperature and the humidity are high, this condition may occur when operation starts. ■ During defrosting mode, cool airflow may blow down and appear like a mist.
Water or vapor is emitted from the outdoor unit.	<ul style="list-style-type: none"> ■ During cooling mode, water may form and drip from the cool pipes and joints. ■ During heating mode, water may form and drip from the heat exchanger. ■ During defrosting mode, water on the heat exchanger evaporates and water vapor may be emitted.
"" appears in the remote controller display.	<ul style="list-style-type: none"> ■ During central control, "" appears in the remote controller display and air conditioner operation cannot be started or stopped using the remote controller.

7. Trouble Shooting

Having trouble?	Here is the solution. (Unit is operating normally.)												
When restarting the air conditioner soon after stopping it, it does not operate even though the ON/OFF button is pressed.	<ul style="list-style-type: none"> Wait approximately 3 minutes. (Operation has stopped to protect the air conditioner.) 												
Air conditioner operates without the ON/OFF button being pressed.	<ul style="list-style-type: none"> Is the on timer set? Press the ON/OFF button to stop operation. Is the air conditioner connected to a central remote controller? Consult the concerned people who control the air conditioner. Does "Ⓞ" appear in the remote controller display? Consult the concerned people who control the air conditioner. Has the auto recovery feature from power failures been set? Press the ON/OFF button to stop operation. 												
Air conditioner stops without the ON/OFF button being pressed.	<ul style="list-style-type: none"> Is the off timer set? Press the ON/OFF button to restart operation. Is the air conditioner connected to a central remote controller? Consult the concerned people who control the air conditioner. Does "Ⓞ" appear in the remote controller display? Consult the concerned people who control the air conditioner. 												
Remote controller timer operation cannot be set.	<ul style="list-style-type: none"> Are timer settings invalid? If the timer can be set, Ⓞ or Ⓟ appears in the remote controller display. 												
"PLEASE WAIT" appears in the remote controller display.	<ul style="list-style-type: none"> The initial settings are being performed. Wait approximately 3 minutes. 												
An error code appears in the remote controller display.	<ul style="list-style-type: none"> The protection devices have operated to protect the air conditioner. Do not attempt to repair this equipment by yourself. Turn off the power switch immediately and consult your dealer. Be sure to provide the dealer with the model name and information that appeared in the remote controller display. 												
Draining water or motor rotation sound is heard.	<ul style="list-style-type: none"> When cooling operation stops, the drain pump operates and then stops. Wait approximately 3 minutes. 												
Noise is louder than specifications.	<ul style="list-style-type: none"> The indoor operation sound level is affected by the acoustics of the particular room as shown in the following table and will be higher than the noise specification, which was measured in anechoic room. <table border="1" style="margin-left: 20px;"> <thead> <tr> <th></th> <th>High sound absorbing rooms</th> <th>Normal rooms</th> <th>Low sound absorbing rooms</th> </tr> </thead> <tbody> <tr> <td>Location examples</td> <td>Broadcasting studio, music room, etc.</td> <td>Reception room, hotel lobby, etc.</td> <td>Office, hotel room</td> </tr> <tr> <td>Noise levels</td> <td>3 - 7 dB</td> <td>6 - 10 dB</td> <td>9 - 13 dB</td> </tr> </tbody> </table>		High sound absorbing rooms	Normal rooms	Low sound absorbing rooms	Location examples	Broadcasting studio, music room, etc.	Reception room, hotel lobby, etc.	Office, hotel room	Noise levels	3 - 7 dB	6 - 10 dB	9 - 13 dB
	High sound absorbing rooms	Normal rooms	Low sound absorbing rooms										
Location examples	Broadcasting studio, music room, etc.	Reception room, hotel lobby, etc.	Office, hotel room										
Noise levels	3 - 7 dB	6 - 10 dB	9 - 13 dB										
Nothing appears in the wireless remote controller display, the display is faint, or signals are not received by the indoor unit unless the remote controller is close.	<ul style="list-style-type: none"> The batteries are low. Replace the batteries and press the Reset button. If nothing appears even after the batteries are replaced, make sure that the batteries are installed in the correct directions (+, -). 												
The operation lamp near the receiver for the wireless remote controller on the indoor unit is blinking.	<ul style="list-style-type: none"> The self diagnosis function has operated to protect the air conditioner. Do not attempt to repair this equipment by yourself. Turn off the power switch immediately and consult your dealer. Be sure to provide the dealer with the model name. 												

8. Specifications

<Cooling/Heating>

Model	PKA-M35HA(L) PKA-M50HA(L)
Power source (voltage <V>/Frequency<Hz>)	~/N 230/50
Rated Input (Indoor only) <kW>	0.04/0.03 0.04/0.03
Rated Current (Indoor only) <A>	0.40/0.30 0.40/0.30
Heater <kW>	- -
Dimension (Height) <mm>	295
Dimension (Width) <mm>	898
Dimension (Depth) <mm>	249
Fan airflow rate (Low-Middle-High) <m ³ /min>	9-10.5-12
Noise level (Low -Middle-High) <dB>	36-40-43
Net weight <kg>	13

Model	PCA-M35KA	PCA-M50KA	PCA-M60KA	PCA-M71KA	PCA-M100KA	PCA-M125KA	PCA-M140KA
Power source (voltage <V>/Frequency<Hz>)	~/N 230/50						
Rated Input (Indoor only) <kW>	0.04/0.04	0.05/0.05	0.06/0.06	0.06/0.06	0.09/0.09	0.11/0.11	0.14/0.14
Rated Current (Indoor only) <A>	0.29/0.27	0.37/0.37	0.39/0.39	0.42/0.42	0.65/0.65	0.76/0.76	0.90/0.90
Heater <kW>	-	-	-	-	-	-	-
Dimension (Height) <mm>	230						
Dimension (Width) <mm>	960	1280		1600			
Dimension (Depth) <mm>	680						
Fan airflow rate (Low-Middle2-Middle1-High) <m ³ /min>	10-11-12-14	10-11-13-15	15-16-17-19	16-17-18-20	22-24-26-28	23-25-27-29	24-26-29-32
Noise level (Low -Middle2-Middle1-High) <dB>	31-33-36-39	32-34-37-40	33-35-37-40	35-37-39-41	37-39-41-43	39-41-43-45	41-43-45-48
Net weight <kg>	25	26	32		37	38	40

Model	PKA-M35HA(L) PKA-M50HA(L)		
Cooling Capacity	sensible P _{rated,c} <kW>	2.83	3.60
	latent P _{rated,c} <kW>	0.67	1.40
Heating Capacity	P _{rated,h} <kW>	4.00	5.70
Total electric power input	P _{elec} <kW>	0.040	
Sound power level (per speed setting, if applicable)	L _{WA} <dB>	53-57-60	

(EU)2016/2281

Model	PCA-M35KA	PCA-M50KA	PCA-M60KA	PCA-M71KA	PCA-M100KA	PCA-M125KA	PCA-M140KA
Cooling Capacity	sensible P _{rated,c} <kW>	3.08	3.95	4.86	5.39	7.70	9.64
	latent P _{rated,c} <kW>	0.42	1.05	1.14	1.71	2.30	3.76
Heating Capacity	P _{rated,h} <kW>	4.00	5.70	6.90	8.10	11.20	16.00
Total electric power input	P _{elec} <kW>	0.040	0.050	0.060		0.090	0.140
Sound power level (per speed setting, if applicable)	L _{WA} <dB>	52-54-57-60		53-55-57-60	56-58-60-62	57-59-61-63	59-61-63-65

(EU)2016/2281

EC DECLARATION OF CONFORMITY
EG-KONFORMITÄTSEKTLÄRUNG
DÉCLARATION DE CONFORMITÉ CE
EG-KONFORMITEITSVERKLARING
DECLARACION DE CONFORMIDAD CE
DICHIARAZIONE DI CONFORMITÀ CE
ΔΗΛΩΣΗ ΠΙΣΤΟΤΗΤΑΣ ΕΚ

DECLARAÇÃO DE CONFORMIDADE CE
EU-OVERENSSTEMMELSESEKTLÆRING
EG-DEKLARATION OM ØVERENSSTÅMMEELSE
EG UYGUNLUK BEYANI
ДЕКЛАРАЦИЯ СООТВЕТСТВИЯ НОРМАМ ЕС
ДЕКЛАРАЦІЯ ВІДПОВІДНОСТІ НОРМАМ ЄС
ЕС ДЕКЛАРАЦІЯ ЗА СЪОТВЕТСТВИЕ

DEKLARACJA ZGODNOŚCI WE
CE-ERKLÆRING OM SAMSVAR
EY-VAATIMUSTENMUKAISUUSVAKUUTUS
ES UYGUNLUK BEYANI
VYHLÁSENIE O ZHODE ES
EK MEGFELELŐSÉGI NYILATKOZAT
IZJAVA O SKLADNOSTI ES

DECLARAȚIE DE CONFORMITATE CE
EÜ VASTAVUSDEKLARATSIOON
EK ATBILSTĪBAS DEKLARĀCIJA
EB ATITIKTĪBAS DEKLARĀCIJA
EC IZJAVA O SUKLADNOSTI
EZ IZJAVA O USAGLAŠENOSTI

**MITSUBISHI ELECTRIC AIR CONDITIONING SYSTEMS EUROPE LTD.
NETTLEHILL ROAD, HOUSTOUN INDUSTRIAL ESTATE, LIVINGSTON, EH54 5EQ, SCOTLAND, UNITED KINGDOM**

hereby declares under its sole responsibility that the air conditioners and heat pumps described below for use in residential, commercial and light-industrial environments:
erklärt hiermit auf seine alleinige Verantwortung, dass die Klimaanlage und Wärmepumpen für das häusliche, kommerzielle und leicht-industrielle Umfeld wie unten beschrieben:
déclare par la présente et sous sa propre responsabilité que les climatiseurs et les pompes à chaleur décrits ci-dessous, destinés à un usage dans des environnements résidentiels, commerciaux et d'industrie légère :
verklaart hierbij onder eigen verantwoordelijkheid dat de voor residentiële, commerciële en licht-industriële omgevingen bestemde airconditioners en warmtepompen zoals onderstaand beschreven:
por la presente declara bajo su única responsabilidad que los acondicionadores de aire y bombas de calor descritas a continuación para su uso en entornos residenciales, comerciales y de industria ligera:
confirma na da presente, sotto la sua esclusiva responsabilità, che i condizionatori d'aria e le pompe di calore descritti di seguito e destinati all'utilizzo in ambienti residenziali, commerciali e semi-industriali:
με το παρόν πιστοποιώ με αποκλειστική της ευθύνης ότι οι τα κλιματιστικά και οι αντλίες θέρμανσης που περιγράφονται παρακάτω για χρήση σε οικιακό, επαγγελματικό και ελαφριάς βιομηχανίας περιβάλλοντα:
através da presente declara sob sua única responsabilidade que os aparelhos de ar condicionado e bombas de calor abaixo descritos para uso residencial, comercial e de indústria ligeira:
erklærer hermed under eneansvar, at de herunder beskrevne airconditioninganlæg og varmepumper til brug i privat boligbyggeri, erhvervsområder og inden for let industri:
intygar härmed att luftkonditioneringarna och värmepumparna som beskrivs nedan för användning i bostäder, kommersiella miljöer och lätta industriella miljöer:
ev, ticaret ve hafif sanayi ortamlarında kullanılmaya uygunluk beyanı için aşağıdaki hususları yalnızca kendi sorumluluğunda beyan eder:
настоящим заявляет и берет на себя исключительную ответственность за то, что кондиционеры и тепловые насосы, описанные ниже и предназначенные для эксплуатации в жилых помещениях, торговых залах и на предприятиях легкой промышленности:
чим заявляю, беручи на себе повну відповідальність за це, що кондиціонери й теплові насоси, описані нижче й призначені для використання в житлових приміщеннях, торговельних залах і на підприємствах легкої промисловості:
декларира на своя собствена отговорност, че климатизите и термопомпите, описани по-долу, за употреба в жилища, търговски и леки промишлени условия:
poiniejszym oświadczam na swoją wyłączną odpowiedzialność, że klimatyzatory i pompy ciepła opisane poniżej, są przeznaczone do zastosowań w środowisku mieszkalnym, handlowym i lekko przemysłowym:
erklærer et fullstendig ansvar for undernevnte klimaanlegg og varmepumper ved bruk i boliger, samt kommersielle og lettindustrielle miljøer:
vakuuttaa täten yksinomaisella vastuullaan, että jäljempänä kuvutatut asuinrakennuksiin, pientaloisuuskäyttöön ja kaupalliseen käyttöön tarkoitettua ilmastointilaitteita ja lämpöpumpuita:
týmto na vlastní odpovědnost prohlašuje, že níže popsané klimatizační jednotky a tepelná čerpadla pro použití v obytných prostředích, komerčních prostředích a prostředích lehkého průmyslu:
týmto na svoju výlučnú zodpovednosť vyhlasuje, že nasledovné klimatizačné jednotky a tepelné čerpadlá určené na používanie v obytných a obchodných priestoroch a v prostredí ľahkého priemyslu:
alulírott kizárólagos felelősségére nyilatkozik, hogy az alábbi lakossági, kereskedelmi és kisipari környezetben való használatra szánt klímaberendezések és hőszivattyúk:
izjavlja pod izključno lastno odgovornostjo, da so spodaj navedene klimatske naprave in toplotne črpalke, namenjene uporabi v stanovanjskih, komercialnih in lahkoindustrijskih okoljih:
declară, prin prezenta, pe proprie răspundere, faptul că aparatele de climatizare și pompele de căldură descrise mai jos și destinate utilizării în medii rezidențiale, comerciale și din industria ușoară:
kinnitab käesolevaga oma ainuvastutuse, et allpool toodud kliimaseadmed ja soojuspumbad on mõeldud kasutamiseks elu-, äri- ja kergtööstuskeskkondades:
ar šo, vienpersoniski uzņemoties atbildību, paziņo, ka tālāk aprakstītie gaisa kondicionētāji un siltumsūkņi ir paredzēti lietošanai dzīvojamajās, komercdarbības un vieglās rūpniecības telpās.
šiuo vien tik savo atsakomybe pareiškia, kad toliau apibūdinti oro kondicionieriai ir šilumos siurbiai skirti naudoti gyvenamosiose, komercinėse ir lengvosios pramonės aplinkose:
ovime izjavljuje pod isključivom odgovornošću da su klimatizacijski uređaji i toplinske dizalice opisane u nastavku namijenjeni za upotrebu u stambenim i poslovnim okruženjima te okruženjima lake industrije:
ovim izjavljuje na svoju isključivu odgovornost da su klima-uređaji i toplotne pumpe opisane u daljem tekstu za upotrebu u stambenim, komercijalnim okruženjima i okruženjima sa lakom industrijom:

**MITSUBISHI ELECTRIC, PKA-M35HA*, PKA-M50HA*
PKA-M35HAL*, PKA-M50HAL*
PCA-M35KA*, PCA-M50KA*, PCA-M60KA*, PCA-M71KA*, PCA-M100KA*, PCA-M125KA*, PCA-M140KA***

Note: Its serial number is on the nameplate of the product.
Hinweis: Die Seriennummer befindet sich auf dem Kennschild des Produkts.
Remarque : Le numéro de série de l'appareil se trouve sur la plaque du produit.
Opmerking: het serienummer staat op het naamplaatje van het product.
Nota: el número de serie se encuentra en la placa que contiene el nombre del producto.
Nota: il numero di serie si trova sulla targhetta del prodotto.
Σημείωση: Ο σειριακός του αριθμός βρίσκεται στην πινακίδα ονόματος του προϊόντος.
Nota: o número de série encontra-se na placa que contém o nome do produto.
Bemærk: Serienummeret står på produktets fabriksskilt.
Obs: Serienumret finns på produktens namnplåt.
Not: Seri numarasi ürünün isim plakasında yer alır.
Примечание: серийный номер указан на паспортной табличке изделия.
Примітка: Серійний номер вказано на паспортній табличці виробу.
Забелужка: Серійний му номер е на табелката на продукта.

Uwaga: Numer seryjny znajduje się na tabliczce znamionowej produktu.
Merk: Seriennummeret befinner seg på navneplaten til produktet.
Huomautus: Sarjanumero on merkitty laitteen arvokilpeen.
Poznámka: Příslušné sériové číslo se nachází na štítku produktu.
Poznámka: Výrobné číslo sa nachádza na typovom štítku výrobku.
Megjegyzés: A sorozatszám a termék adattábláján található.
Opomba: serijska številka je zapisana na tipski ploščici enote.
Notă: Numărul de serie este specificat pe plăcuța indicatoare a produsului.
Märkus: Seriennummer asub toote andmesilidil.
Piezīme: Sērijas numurs ir norādīts uz ierīces datu plāksnītes.
Pastaba: Serijos numeris nurodytas gaminio vardinių duomenų lentelėje.
Napomena: serijski broj nalazi se na natpisnoj pločici proizvoda.
Napomena: Serijski broj nalazi se na nazivnoj pločici proizvoda.

Directives
Richtlijnen
Directives
Richtlijnen
Directivas
Direttive
Οδηγίες

Directivas
Direktiver
Direktiv
Direktifler
Директивы
Директиви

Dyrektywy
Direktiver
Direktivit
Směrnice
Smernice
Írányelvek
Direktive

Directive
Direktiivid
Direktivas
Direktivos
Direktive
Direktive

2014/35/EU: Low Voltage
2006/42/EC: Machinery
2014/30/EU: Electromagnetic Compatibility
2011/65/EU: RoHS Directive
2009/125/EC: Energy-related Products and Regulation (EU) No 206/2012*
*Only 35/50/60/71

Issued: 1 February, 2017
JAPAN

Takuo AKIYAMA
Manager Quality Assurance Department

<ENGLISH>

English is original. The other languages versions are translation of the original.

⚠ CAUTION

- Refrigerant leakage may cause suffocation. Provide ventilation in accordance with EN378-1.
- Be sure to wrap insulation around the piping. Direct contact with the bare piping may result in burns or frostbite.
- Never put batteries in your mouth for any reason to avoid accidental ingestion.
- Battery ingestion may cause choking and/or poisoning.
- Install the unit on a rigid structure to prevent excessive operation sound or vibration.
- Noise measurement is carried out in accordance with JIS C9612, JIS B8616, ISO 5151(T1), and ISO 13523(T1).

<DEUTSCH>

Das Original ist in Englisch. Die anderen Sprachversionen sind vom Original übersetzt.

⚠ VORSICHT

- Das Auslaufen von Kältemittel kann zu Erstickung führen. Sorgen Sie für Belüftung gemäß der Bestimmung EN378-1.
- Sicherstellen, dass die Rohrführung isoliert ist. Direkter Kontakt mit der blanken Rohrleitung kann zu Verbrennungen oder Erfrierungen führen.
- Nehmen Sie unter keinen Umständen Batterien in den Mund, um versehentliches Verschlucken zu vermeiden.
- Das Verschlucken von Batterien kann zu Erstickung und/oder Vergiftung führen.
- Installieren Sie das Gerät an einer stabilen Struktur, um übermäßige Betriebsgeräusche oder Vibration zu vermeiden.
- Geräuschmessungen werden gemäß der Bestimmungen JIS C9612, JIS B8616, ISO 5151(T1), und ISO 13523(T1) ausgeführt.

<FRANÇAIS>

L'anglais est l'original. Les versions fournies dans d'autres langues sont des traductions de l'original.

⚠ PRECAUTION

- Une fuite de réfrigérant peut entraîner une asphyxie. Fournissez une ventilation adéquate en accord avec la norme EN378-1.
- Assurez-vous que la tuyauterie est enveloppée d'isolant. Un contact direct avec la tuyauterie nue peut entraîner des brûlures ou des engelures.
- Ne mettez jamais des piles dans la bouche pour quelque raison que ce soit pour éviter de les avaler par accident.
- Le fait d'ingérer des piles peut entraîner un étouffement et/ou un empoisonnement.
- Installez l'unité sur une structure rigide pour prévenir un bruit de fonctionnement et une vibration excessifs.
- Les mesures de niveau sonore ont été effectuées en accord avec les normes JIS C9612, JIS B8616, ISO 5151(T1) et ISO 13523(T1).

<NEDERLANDS>

Het Engels is het origineel. De andere taalversies zijn vertalingen van het origineel.

⚠ VOORZICHTIG

- Het lekken van koelvloeistof kan verstikking veroorzaken. Zorg voor ventilatie in overeenstemming met EN378-1.
- isoleer de leidingen met isolatiemateriaal. Direct contact met de onbedekte leidingen kan leiden tot brandwonden of bevriezing.
- Stop nooit batterijen in uw mond om inslikking te voorkomen.
- Het inslikken van batterijen kan verstikking of vergiftiging veroorzaken.
- Installeer het apparaat op een stabiele structuur om overmatig lawaai of trillingen te voorkomen.
- Geluidsmetingen worden uitgevoerd in overeenstemming met JIS C9612, JIS B8616, ISO 5151(T1), en ISO 13523(T1).

<ESPAÑOL>

El idioma original del documento es el inglés. Las versiones en los demás idiomas son traducciones del original.

⚠ CUIDADO

- Las pérdidas de refrigerante pueden causar asfixia. Se debe proporcionar la ventilación determinada en EN378-1.
- Asegúrese de colocar el aislante alrededor de las tuberías. El contacto directo con la tubería puede ocasionar quemaduras o congelación.
- Para evitar una ingestión accidental, no coloque las pilas en su boca bajo ningún concepto.
- La ingestión de las pilas puede causar asfixia y/o envenenamiento.
- Coloque la unidad en una estructura rígida para evitar que se produzcan sonidos o vibraciones excesivos debidos a su funcionamiento.
- La medición de los ruidos se lleva a cabo de acuerdo con JIS C9612, JIS B8616, ISO 5151(T1) y ISO 13523(T1).

<ITALIANO>

Il testo originale è redatto in lingua Inglese. Le altre versioni linguistiche rappresentano traduzioni dell'originale.

⚠ ATTENZIONE

- Perdite di refrigerante possono causare asfissia. Prevedere un ventilazione adeguata in conformità alla norma EN378-1.
- Accertarsi di applicare materiale isolante intorno alle tubature. Il contatto diretto con le tubature non schermate può provocare ustioni o congelamento.
- Non introdurre in nessun caso le batterie nella bocca onde evitare ingestioni accidentali.
- L'ingestione delle batterie può provocare soffocamento e/o avvelenamento.
- Installare l'unità su di una struttura rigida in modo da evitare rumore o vibrazioni eccessivi durante il funzionamento.
- La misurazione del rumore viene effettuata in conformità agli standard JIS C9612, JIS B8616, ISO 5151(T1) e ISO 13523(T1).

<ΕΛΛΗΝΙΚΑ>

Η γλώσσα του πρωτοτύπου είναι η αγγλική. Οι εκδόσεις άλλων γλωσσών είναι μεταφράσεις του πρωτοτύπου.

⚠ ΠΡΟΣΟΧΗ

- Η διαρροή του ψυκτικού ενδέχεται να προκαλέσει ασφυξία. Φροντίστε για τον εξαερισμό σύμφωνα με το EN378-1.
- Βεβαιωθείτε ότι τυλίξατε με μονωτικό υλικό τη σωλήνωση. Η απευθείας επαφή με τη γυμνή σωλήνωση ενδέχεται να προκαλέσει εγκαύματα ή κρυοπαγήματα.
- Μην βάζετε ποτέ τις μπαταρίες στο στόμα σας για κανένα λόγο ώστε να αποφύγετε την κατά λάθος κατάποσή τους.
- Η κατάποση μπαταριών ενδέχεται να προκαλέσει πνιγμό και/ή δηλητηρίαση.
- Εγκαταστήστε τη μονάδα σε σταθερή κατασκευή ώστε να αποφύγετε τον έντονο ήχο λειτουργίας ή τους κραδασμούς.
- Η μέτρηση θορύβου πραγματοποιήθηκε σύμφωνα με τα JIS C9612, JIS B8616, ISO 5151(T1) και ISO 13523(T1).

<PORTUGUÊS>

O idioma original é o inglês. As versões em outros idiomas são traduções do idioma original.

⚠ CUIDADO

- As fugas de refrigerante podem provocar asfixia. Proporcione ventilação de acordo com a EN378-1.
- Certifique-se de que coloca isolamento em redor da tubagem. O contacto directo com a tubagem pode resultar em queimaduras ou úlceras causadas pelo frio.
- Para evitar uma ingestão accidental, nunca coloque pilhas na boca.
- A ingestão das pilhas pode provocar asfixia e/ou envenenamento.
- Instale a unidade numa estrutura rígida para evitar vibrações ou ruídos excessivos durante o seu funcionamento.
- A medição dos ruídos é efectuada de acordo com a JIS C9612, JIS B8616, ISO 5151(T1), e ISO 13523(T1).

<DANSK>

Engelsk er originalen. De andre sprogversioner er oversættelser af originalen.

⚠ FORSIGTIG

- Kølemiddellækage kan forårsage kvælning. Sørg for ventilation i henhold til EN378-1.
- Der skal altid vikles isolering omkring rørene. Direkte kontakt med blotlagte rør kan medføre forbrænding eller forfrysning.
- Put aldrig batterier i munden uanset årsag, du kan komme til at sluge dem.
- Hvis batterier sluges, kan det medføre kvælning og/eller forgiftning.
- Monter enheden på en fast struktur, så kraftig lyd og vibration undgås.
- Støjmåling udføres i henhold til JIS C9612, JIS B8616, ISO 5151(T1) og ISO 13523(T1).

<SVENSKA>

Engelska är originalspråket. De övriga språkversionerna är översättningar av originalet.

⚠ FÖRSIKTIGHET

- Köldmedelsläckage kan leda till kvävning. Tillhandahåll ventilation i enlighet med EN378-1.
- Kom ihåg att linda isolering runt rören. Direktkontakt med bara rör kan leda till brännskador eller köldskador.
- Stoppa aldrig batterier i munnen, de kan sväljas av misstag.
- Om ett batteri sväljs kan det leda till kvävning och/eller förgiftning.
- Montera enheten på ett stadigt underlag för att förhindra höga driftljud och vibrationer.
- Ljudmätningar har utförts i enlighet med JIS C9612, JIS B8616, ISO 5151(T1) och ISO 13523(T1).

<TÜRKÇE>

Aslı İngilizce'dir. Diğer dillerdeki sürümler aslının çevirisidir.

⚠ DİKKAT

- Soğutucu sızıntısı boğulma tehlikesine yol açabilir. EN378-1'e göre havalandırma sağlayın.
- Boruların etrafına izolasyon malzemesi kaplamayı unutmayın. Çıplak boruya doğrudan temas etmek yanmaya ve soğuk ısırmasına neden olabilir.
- Yanlışlıkla yutmamak için pilleri hiçbir nedenle asla ağzınıza sokmayın.
- Pili yutmak boğulmaya ve/veya zehirlenmeye neden olabilir.
- Aşırı çalışma sesinin veya titreşimin oluşmaması için üniteyi sert bir yapı üzerine kurun.
- Ses ölçümü JIS C9612, JIS B8616, ISO 5151(T1), ve ISO 13523(T1) standartlarına göre yapılır.

<РУССКИЙ>

Языком оригинала является английский. Версии на других языках являются переводом оригинала.

⚠ ОСТОРОЖНО

- Утечка хладагента может стать причиной удущья. Обеспечьте вентиляцию в соответствии с EN378-1.
- Обязательно оберните трубы изоляционной обмоткой. Непосредственный контакт с неизолированным трубопроводом может привести к ожогам или обморожению.
- Запрещается класть элементы питания в рот по каким бы то ни было причинам во избежание случайного проглатывания.
- Попадание элемента питания в пищеварительную систему может стать причиной удущья и/или отравления.
- Устанавливайте устройство на жесткую структуру во избежание чрезмерного шума или чрезмерной вибрации во время работы.
- Измерение шума выполняется в соответствии с JIS C9612, JIS B8616, ISO 5151(T1) и ISO 13523(T1).

<УКРАЇНСЬКА>

Переклад оригіналу. Текст іншими мовами є перекладом оригіналу.

⚠ ОБЕРЕЖНО

- Виток холодоагенту може призвести до удущення. Необхідно забезпечити вентиляцію відповідно до стандарту EN 378-1.
- Труби необхідно обмотати ізоляційним матеріалом. Прямий контакт із непокритою трубою може призвести до опіку або обмороження.
- Забороняється класти елементи живлення в рот із будь-яких причин, оскільки є ризик випадково їх проковтнути.
- Попадання елемента живлення в травну систему може стати причиною задухи та/або отруєння.
- Встановлюйте блок на міцній конструкції, щоб уникнути надмірного рівня звуку роботи або вібрації.
- Вимірювання рівня шуму проводилося згідно з JIS C9612, JIS B8616, ISO 5151(T1), і ISO 13523(T1).

<БЪЛГАРСКИ>

Оригиналът е текстът на английски език. Версиите на други езици са преводи на оригинала.

⚠ ВНИМАНИЕ

- Изтичането на хладилния агент може да причини задушаване. Осигурете вентилация съобразно с EN378-1.
- Не забравяйте да увиете изолация около тръбите. Директният контакт с оголени тръби може да причини изгаряне или измръзване.
- При никакви обстоятелства не поставяйте батериите в устата си, за да не ги погълнете по невнимание.
- Това може да доведе до задушаване и/или натравяне.
- Монтирайте тялото върху твърда конструкция, за да предотвратите прекомерен шум или вибрации по време на работа.
- Измерването на шума е извършено съгласно JIS C9612, JIS B8616, ISO 5151(T1) и ISO 13523(T1).

<POLSKI>

Językiem oryginalu jest język angielski. Inne wersje językowe stanowią tłumaczenie oryginalu.

⚠ UWAGA

- Wyciek czynnika chłodniczego może spowodować uduszenie. Należy zapewnić wentylację zgodnie z normą EN378-1.
- Należy pamiętać, aby owinać izolację wokół przewodów rurowych. Bezpośredni kontakt z niezabezpieczonymi przewodami rurowymi może doprowadzić do poparzeń lub odmrożeń.
- Nie wolno wkładać baterii do ust z jakiegokolwiek powodu, aby uniknąć przypadkowego połknięcia.
- Połknięcie baterii może spowodować zadławienie i/lub zatrucie.
- Zainstalować urządzenie na sztywnej konstrukcji, aby zapobiec nadmiernemu hałasowi i wibracjom.
- Pomiar hałasu należy przeprowadzać zgodnie z normami JIS C9612, JIS B8616, ISO 5151(T1) i ISO 13523(T1).

<NORSK>

Originalspråket er engelsk. De andre språkversjonene er oversettelser av originalen.

⚠ FORSIKTIG

- Kjølemiddelkassje kan forårsake kvelning. Sørg for ventilering i samsvar med EN378-1.
- Pass på at isoleringen pakkes godt rundt røret. Direkte kontakt med ukledte rør kan forårsake brannskader eller forfrysninger.
- Aldri plasser batteri i munnen, da dette kan medføre en risiko for at du svelger batteriet ved et uhell.
- Hvis du svelger et batteri, kan du risikere kvelning og/eller forgiftning.
- Installer enheten på en stabil struktur for å forhindre unødvendig mye driftsstøy eller vibrering.
- Støymålinger er utført i samsvar med JIS C9612, JIS B8616, ISO 5151(T1) og ISO 13523(T1).

<SUOMI>

Englanti on alkuperäinen. Muut kieliversiot ovat alkuperäiskappaleen käänköksiä.

⚠ HUOMIO

- Vuotava kylmäaine voi aiheuttaa tukehtumisen. Ilmanvaihdon on oltava EN378-1-standardin mukainen.
- Kaäri putken ympärille eristysmateriaalia. Paljaan putken koskettamisesta voi seurata palotai paleltumavammoja.
- Älä koskaan laita paristoja suuhun, jotta et vahingossa nielaisisi niitä.
- Paristojen nieleminen voi aiheuttaa tukehtumisen ja/tai myrkytyksen.
- Asenna yksikkö tukeviin rakenteisiin, jotta sen käytöstä ei syntyisi ylimääräistä ääntä tai värinää.
- Melumittaus on suoritettu standardien JIS C9612, JIS B8616, ISO 5151(T1) ja ISO 13523(T1) mukaisesti.

<ČEŠTINA>

Originál je v angličtině. Ostatní jazykové verze jsou překladem originálu.

⚠ POZOR

- Únik chladicího média může způsobit udušení. Zajistěte větrání v souladu s normou EN 378-1.
- Okolo potrubí vždy omotejte izolaci. Přímý kontakt s obnaženým potrubím může způsobit popálení nebo omrzliny.
- Nikdy nevklaďte baterie do úst, aby nedošlo k jejich polknutí.
- Polknutí baterie může způsobit zadušení a/nebo otravu.
- Jednotku nainstalujte na pevnou konstrukci, aby nedocházelo ke vzniku nadměrného provozního hluku a vibrací.
- Měření hluku se provádí v souladu se standardy JIS C9612, JIS B8616, ISO 5151(T1) a ISO 13523(T1).

<SLOVENČINA>

Preklad anglického originálu. Všetky jazykové verzie sú preložené z angličtiny.

⚠ UPOZORNENIE

- Únik chladiva môže spôsobiť udusenie. Zabezpečte vetranie podľa normy EN 378-1.
- Nezapadnite potrubie obaliť izoláciou. Priamy kontakt s nezabaleným potrubím môže spôsobiť popálenie alebo omrzliny.
- Batérie si nikdy z akéhokolvek dôvodu nekladte do úst, aby nedošlo k ich náhodnému požitiu.
- Požitie batérií môže vyvolať dusenie a/alebo otravu.
- Nainštalujte jednotku na pevný konštrukčný prvok, aby ste obmedzili nadmerný prevádzkový hluč a vibrácie.
- Meranie hladiny hluku sa vykonáva v súlade s normami JIS C9612, JIS B8616, ISO 5151(T1), a ISO 13523(T1).

<MAGYAR>

Az angol változat az eredeti. A többi nyelvi változat az eredeti fordítása.

⚠ VIGYÁZAT

- A hűtőközeg szivárgása fulladást okozhat. Gondoskodjon az EN378-1 szabvány előírásai szerinti szellőzéstől.
- Feltétlenül szigetelje körbe a csöveket. A csupasz cső megérintése égési vagy fagyási sérülést okozhat.
- Ne vegyen a szájába elemet semmilyen célból, mert véletlenül lenyelheti!
- A lenyelt elem fulladást és/vagy mérgezést okozhat.
- A készüléket merev szerkezetre szerelje fel, hogy megakadályozza a túlzott üzemi zajt és vibrációt.
- A zaj mérése a JIS C9612, a JIS B8616, az ISO 5151 (T1) és az ISO 13523 (T1) szabványok előírásai szerint történik.

<SLOVENŠČINA>

Izvirnik je v angleščini. Druge jezikovne različice so prevodi izvirnika.

⚠ POZOR

- Puščanje hladiva lahko povzroči zadušenje. Zagotovite prezračevanje po standardu EN378-1.
- Cevi ovijte z izolacijo. Neposredni stik z golimi cevimi lahko povzroči opekline ali ozeblino.
- Nikoli in iz nobenega razloga ne vstavljajte baterij v usta, da jih po nesreči ne pogoltnete.
- Če baterije pogoltnete, se lahko zadušite in/ali zastrupite.
- Enoto namestite na togo konstrukcijo, da preprečite pretiran zvok ali tresenje med delovanjem.
- Meritve hrupa so bile izvedene skladno z JIS C9612, JIS B8616, ISO 5151(T1) in ISO 13523(T1).

<ROMÂNĂ>

Textul original este în limba engleză. Versiunile pentru celelalte limbi sunt traduceri ale originalului.

⚠ ATENȚIE

- Scurgerea de agent frigorific poate cauza asfixierea. Asigurați o ventilație corespunzătoare, conform standardului EN378-1.
- Asigurați-vă că înfășurați materialul izolator în jurul conductelor. Contactul direct cu conductele neizolate se poate solda cu arsuri sau degerături.
- Nu introduceți niciodată și pentru niciun motiv bateriile în gură, pentru a evita ingerarea accidentală a acestora.
- Ingerarea bateriilor poate cauza sufocarea și/sau intoxicarea.
- Instalați unitatea pe o structură rigidă pentru a preveni producerea unui nivel excesiv de sunete sau vibrații.
- Măsurarea zgomotului este efectuată în conformitate cu standardele JIS C9612, JIS B8616, ISO 5151(T1) și ISO 13523(T1).

<EESTI>

Originaaljuhend on ingliskeelne. Muudes keeltes versioonid on originaali tõlked.

⚠ ETTEVAATUST!

- Külmaaine leke võib põhjustada lämbumist. Tuulutamine standardi EN378-1 kohaselt.
- Märkige torude ümber kindlasti isolatsiooni. Vahetu kontakt paljaste torudega võib põhjustada põletusi või külmakahjustusi.
- Hoiduge patareide tahmatust allaneelamisest, ärge kunagi pange ühelgi põhjusel patareid suhu.
- Patareid allaneelamine võib põhjustada lämbumist ja/või mürgitust.
- Paigaldage seade jäigale struktuurile, et vältida ülemäärast töeheli ja vibreerimist.
- Müratase on mõõdetud standardite JIS C9612, JIS B8616, ISO 5151(T1) ja ISO 13523(T1) järgi.

<LATVIŠKI>

Origināls ir angļu valodā. Versijas citās valodās ir oriģināla tulkojums.

⚠ UZMANĪBU

- Aukstumaģenta noplūdes gadījumā pastāv nosmakšanas risks. Ir jānodrošina standartam EN378-1 atbilstoša ventilācija.
- Aptiniet caurules ar izolējošu materiālu. Pieskaroties neapītiņam caurulēm, var gūt apdegumus vai apsaldējumus.
- Aizliegts ievietot baterijas mutē; pastāv norīšanas risks.
- Bateriju norīšana var izraisīt aizrīšanas un/vai saindēšanas.
- Uzstādiet iekārtu uz izturīgas struktūras, lai izvairītos no pārlieku liela darbības trokšņa vai vibrācijas.
- Trokšņa mērījumi tiek veikti atbilstīgi standartu JIS C9612, JIS B8616, ISO 5151(T1) un ISO 13523(T1) nosacījumiem.

<LIETUVIŠKAI>

Originalas yra anglų k. Versijos kitomis kalbomis yra originalo vertimas.

⚠ ATSARGIAI

- Dėl šaltnešio nuotėkio galima uždusti. Išvėdinkite patalpas pagal EN378-1.
- Būtinai vamzdelius apvyniokite izoliacija. Prisiilietus prie plikų vamzdelių galima nusideginti arba nušalti.
- Siekdami išvengti atsitiktinio prarijimo, niekada nedėkite baterijų į burną.
- Prarijus bateriją galima užspringti ir / arba apsinuodyti.
- Įrenginį sumontuokite ant tvirtos struktūros, kad nesigirdėtų pernelyg didelio veikimo triukšmo ar vibracijos.
- Triukšmo matavimas atliktas pagal JIS C9612, JIS B8616, ISO 5151(T1) ir ISO 13523(T1).

<HRVATSKI>

Tekst je izvorno napisan na engleskom jeziku. Tekst na ostalim jezicima predstavljaju prijevod izvorno napisanog teksta.

⚠ OPREZ

- Čurenje rashladnog sredstva može uzrokovati gušenje. Osigurajte ventilaciju u skladu s normom HR EN378-1.
- Obavezno stavite izolaciju oko položenih cijevi. Izravni doticaj s golim cijevima može dovesti do opekline ili smrzavanja.
- Nikada ne stavljajte baterije u usta ni zbog kojeg razloga kako biste izbjegli slučajno gutanje.
- Gutanje baterija može prouzročiti gušenje i/ili trovanje.
- Postavite jedinicu na čvrstu površinu kako biste izbjegli prebučan zvuk tijekom rada ili pojavu vibracija.
- Mjerenje zvuka obavljeno je sukladno normama JIS C9612, JIS B8616, ISO 5151(T1) i ISO 13523(T1).

<SRPSKI>

Prevod originala. Verzije na drugim jezicima su prevodi originala.

⚠ OPREZ

- Čurenje rashladne tečnosti može da dovede do gušenja. Obezbedite ventilaciju u skladu sa EN378-1.
- Obavezno obmotajte izolaciju oko cevi. Direktna kontakta sa golom cevima može izazvati opekotine ili promrzline.
- Nikada nemojte stavljati baterije u usta iz bilo kog razloga, kako bi se sprečilo slučajno gutanje.
- Ugradite jedinicu na čvrstu strukturu kako biste sprečili previše jak zvuk rada ili vibracije.
- Mjerenje jačine zvuka je obavljeno u skladu sa standardima JIS C9612, JIS B8616, ISO 5151(T1) i ISO 13523(T1).

This product is designed and intended for use in the residential,
commercial and light-industrial environment.

Importer:

Mitsubishi Electric Europe B.V.
Capronilaan 46, 1119 NS, Schiphol Rijk, The Netherlands

French Branch
25, Boulevard des Bouvets, 92741 Nanterre Cedex, France

German Branch
Mitsubishi-Electric-Platz 1, 40882 Ratingen, Germany

Belgian Branch
Autobaan 2, 8210 Loppem, Belgium

Irish Branch
Westgate Business Park, Ballymount, Dublin 24, Ireland

Italian Branch
Centro Direzionale Colleoni, Palazzo Sirio-Ingresso 1 Viale Colleoni 7, 20864 Agrate Brianza
(MB), Italy

Norwegian Branch
Gneisveien 2D, 1914 Ytre Enebakk, Norway

Portuguese Branch
Avda. do Forte, 10, 2799-514, Carnaxide, Lisbon, Portugal

Spanish Branch
Carretera de Rubi 76-80 - Apdo. 420 08173 Sant Cugat del Valles (Barcelona), Spain

Scandinavian Branch
Hammarbacken 14, P.O. Box 750 SE-19127, Sollentuna, Sweden

UK Branch
Travellers Lane, Hatfield, Herts., AL10 8XB, England, U.K.

Polish Branch
Krakowska 50, PL-32-083 Balice, Poland

MITSUBISHI ELECTRIC TURKEY ELEKTRİK ÜRÜNLERİ A.Ş.
Şerifali Mah. Kale Sok. No: 41 34775 Ümraniye, İstanbul / Turkey

Please be sure to put the contact address/telephone number on
this manual before handing it to the customer.

MITSUBISHI ELECTRIC CORPORATION

HEAD OFFICE: TOKYO BUILDING, 2-7-3. MARUNOUCHI, CHIYODA-KU, TOKYO 100-8310, JAPAN